

# THE NEW COMPACT CLASS SONDERHOFF SMART-M AND SMART-L

Dosing cell in two sizes for two or three material components



# The SONDERHOFF SMART with DM 50x technology

## Dosing cell with the highest process stability for automated sealing, bonding and potting

The latest generation of SONDERHOFF SMART dosing cells with the new DM 50x technology features numerous innovative improvements. They are all designed to ensure maximum process stability during the fully automated dispensing of polyurethane or silicone-based 2K material systems for seal foaming, bonding and potting. As before, you can obtain the dosing cell of our new compact class in two sizes, the smaller SMART-M and the larger SMART-L. They differ primarily in the dimensions of the cell and the size of the working area.

### Innovative Mixing Head for the Highest Demands

Both SMART low-pressure mixing and dosing cells can be equipped with the precision mixing heads from the MK 800 series. Integrated sensors on the MK 800 PRO and MK 825 PRO mixing head allow important machine parameters to be measured in order to ensure an optimal application process and higher machine availability at all times:

- Positioning and rotational speed control of the agitator in the mixing chamber,
- Sensor-monitored axial position of the agitator shaft,
- Automatic stroke adjustment of the agitator with stepper motor and position monitoring,
- Automatic air loading for an optimum cell structure of the foam gasket,
- Sensor-monitored position of the dosing needle made of high-performance plastic in the shot and recirculation valve.

### Broad Data Basis for Optimized Process Evaluation and Control

The use of the MK 800 mixing head technology in SONDERHOFF SMART dosing cells means that many sensors collect a large amount of data from the whole FIP (Formed-In-Place) application process. This enables uninterrupted monitoring of and compliance with critical process parameters.

The automatic logging of system, material and process data ensures traceable transparency of the production sequence at any time.

And it creates a comprehensive data pool that enables fast and precise data analysis for optimized process evaluation and control.

With the new generation of SONDERHOFF SMART dosing cells and their innovative technology, individual and at the same time efficient, highly productive and reliable production solutions can be realized. We offer a comprehensive service concept to ensure continuously high machine availability. The fundamental idea here is preventive and planned maintenance.



# An overview of the SONDERHOFF SMART family

## Automated System Solutions for Advanced Material Dosing



SONDERHOFF SMART-L dosing cell with lifting door and MK 825 PRO mixing head, configured for two or optionally three material components



SONDERHOFF SMART-M dosing cell with lifting door and MK 825 PRO mixing head, configured for two material components. Shown with optional CONTROL 2 multi-touch operating panel and signal tower.

The SONDERHOFF SMART-L for two or optionally three material components and the SONDERHOFF SMART-M for two material components are low-pressure mixing and dosing machines in a cellular design that precisely process liquid, medium- and high-viscosity plastics such as polyurethanes, silicones, epoxy resins or other polymer reaction materials. Both dosing cells are used for the semi-automatic and fully automatic application of sealing foams, adhesives and potting compounds to a wide variety of components. They differ primarily in the dimensions of the cell and the size of the working area for moving the mixing head above the component. Without the roof, the cell measures 2.20 m in height. This means that the dosing cell can be transported in overseas containers where the door opening is 2.28 m high in accordance with the ISO standard.

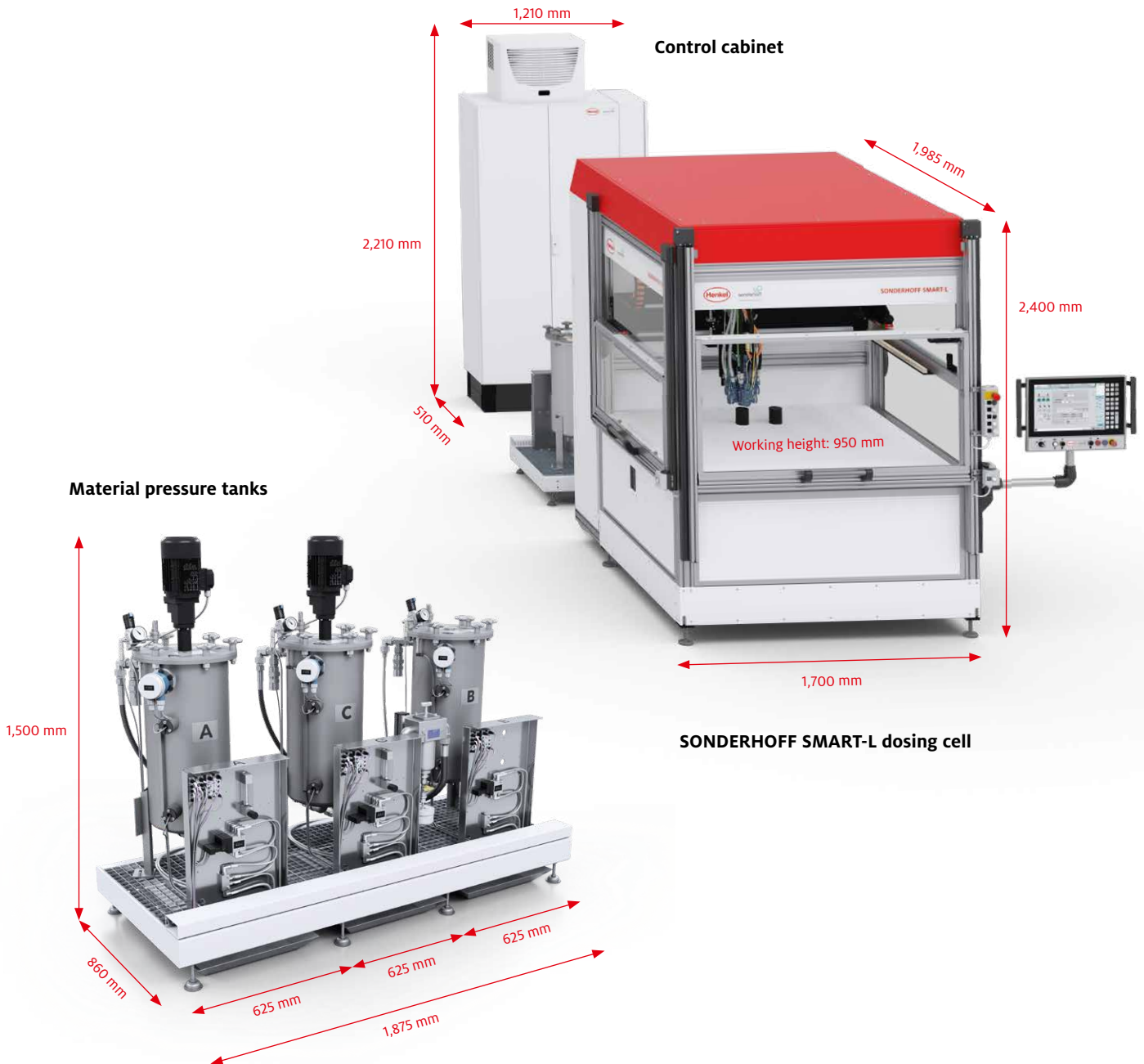

SPECIFICATIONS	SONDERHOFF SMART-L	SONDERHOFF SMART-M
External dimensions (W x H x D mm)	1,700 x 2,400 x 1,985	1,200 x 2,400 x 1,700
Working area height (mm)	950	950
Travel range of the mixing head in the cell (x/y/z mm)	1,000 x 800 x 250	500 x 600 x 250

# The SONDERHOFF SMART Dosing Cell Components

## Perfectly Matched Components

For economical and efficient production and optimal product quality, many process steps must be coordinated in the best possible way. Particularly, the precisely coordinated interaction of material, machine and process for fully automatic material application to the components, the automation of component feed and discharge for dosage and the contour-accurate guidance of the mixing head above the component guarantee a precise and effective process.

For this purpose Henkel not only offers dosing cells with the highest precision, but above all the process experts who, with their many years of experience, implement the best individual solution for our customers.

### Mixing and Dosing

The quality of the installed components and the technical equipment features of a mixing and dosing machine such as the SMART dosing cell set the standard for the best possible implementation of production quality. The high process reliability of the dosing cell is demonstrated by the repeatability of the mixing head positioning over the component and thus the accurate contours and dimensions during material application.

Other examples of process reliability include the recirculation system that stabilizes the material pressure, the sophisticated mixing head cooling system, temperature-controlled, double-walled material tanks, the automatic calibration of the dosing nozzle and much more.

### Control and Monitoring

Besides the mixing head, the control center of our mixing and dosing system is one of the most important components. It is located in an air-conditioned control cabinet in which other high-quality and durable control components from well-known manufacturers are installed in a protected manner.

The dosing system is operated intuitively via the multi-function MP 2 Mobile Panel or optionally with the Control 2 multi-touch operating panel.

### Moving and Automating

Coordination of the movement sequences of the mixing head is an art in itself and therefore at the same time the second crucial pillar of a manufacturing process with a reliable degree of repeat accuracy. On the one hand, this involves precise guidance of the CNC-controlled mixing head above the component, and on the other hand, automated component handling, thus feeding and discharging the components to and from the dosing cell.

Moreover, we offer various automation solutions for the SMART dosing cell.

### Technical service

The productivity and efficiency of the SMART dosing cell is significantly determined by its reliable availability. This is why we ensure the intelligent minimization of error-related downtimes and maintenance-related production interruptions.

For the technical service of our mixing and dosing systems such as the SMART dosing cell, we offer our customers a wide range of different service packages. They can be adapted to each customer's individual situation and include proactive inhouse service, e.g. risk analyses as well as competent on-site service and responsive online service, keyword: Remote Collaboration. In this way, we support you with the reliable planning and execution of your production processes as well as predictive maintenance.

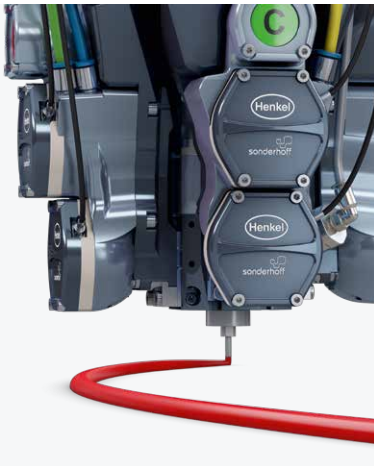

## Mixing and Dosing 8

Mixing heads of the MK 800 family .....	12
Dosing machine cabinet .....	16
Material pressure tank .....	18
Refilling stations.....	20
Optional extensions .....	22



## Control and Monitoring 24

Control cabinet .....	28
Mobile panel and operating panel.....	30
Visualization of the user interfaces.....	32



## Variants and automation 34

SMART-L/M dosing cells with different travel ranges.....	36
SMART-L/M dosing cells with lifting door .....	38
SMART-M dosing cell with rotary indexing table .....	40
SMART-L dosing cell with shuttle/sliding table.....	42
SMART-L dosing cell with transfer belt .....	44



## Technical Service 46

Combined service package for the all-round service.....	48
---	----

# MIXING AND DOSING

## Mixing heads of the MK 800 family

Page 12

## Dosing machine cabinet

Page 16

## Material pressure tank

Page 18

## Refilling stations

Page 20

## Optional extensions

Page 22





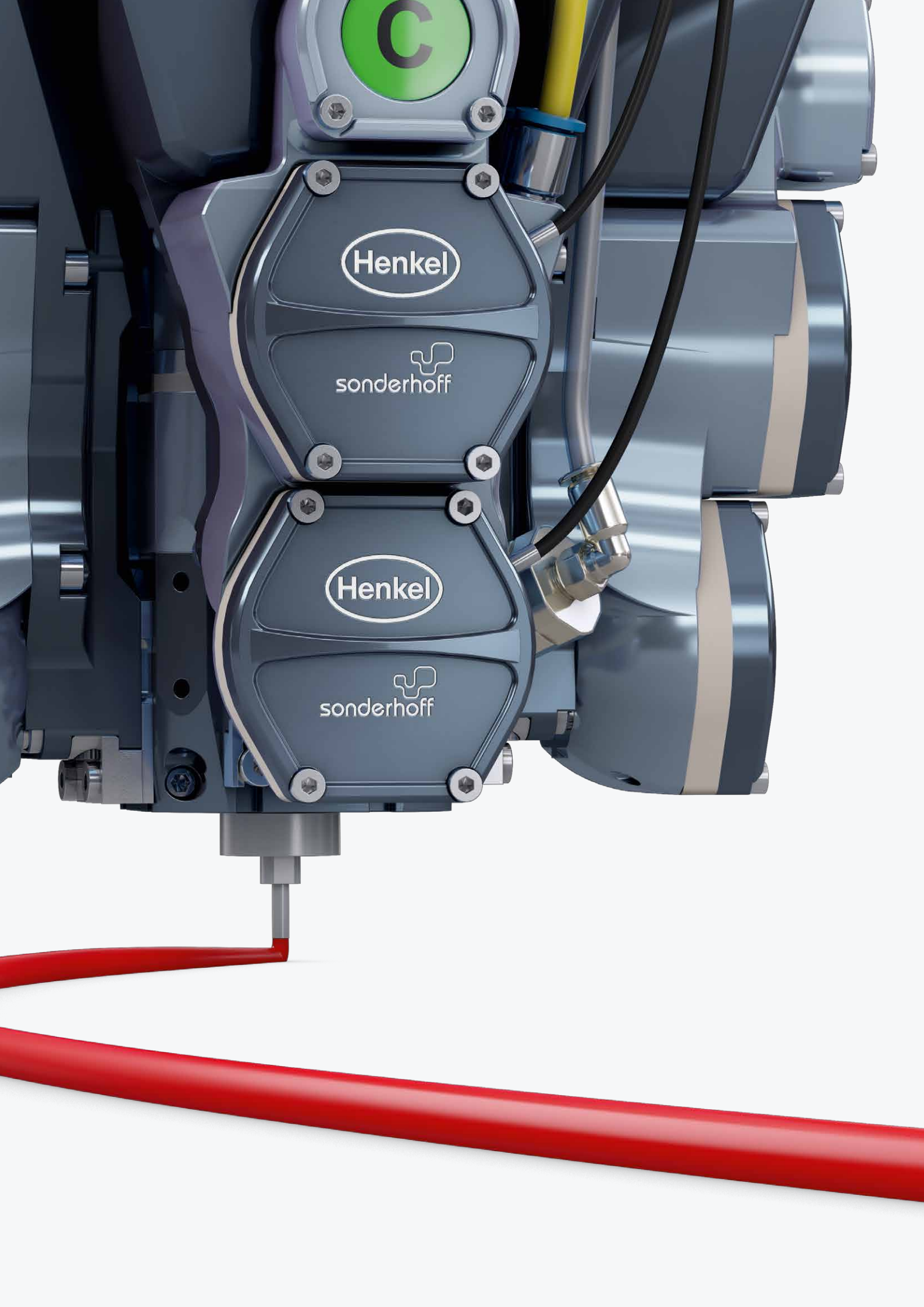

Henkel

sonderhoff

Henkel

sonderhoff

# SMART Mixing and Dosing

## Experience and Precision in every Machine Component

SONDERHOFF SMART-L and SMART-M dosing cells offer automation solutions for mixing and dosing 2-component reaction materials – especially polyurethanes, silicones and epoxy systems – for fully automatic seal foaming, bonding and potting.

The dosing cells include the new DM 50x technology with the MK 800 precision mixing heads, precision gear pumps for dosage of the material components, the air loading measuring device as well as temperature control and the ecological high-pressure water rinsing for cleaning the mixing heads, as well as other optional equipment options for increasing the process and dosing accuracy.

2C reaction materials are conditioned per component in material pressure tanks, e.g. stirred in the tank for uniform material homogenization, loaded with air for seal foaming or evacuated for potting.

Each of the process steps involved has its own specific requirements. Our experience acquired over decades of machine development makes the difference and thus ensures the reliability of our machines for fully automatic material application.

### **Dynamic mixing makes the difference**

The greatest possible material homogeneity after mixing 2-component material systems with different viscosities can be achieved by dynamic mixing, especially in the case of challenging, asymmetrical mixing ratios. This is handled by our new MK 800 mixing heads.

Static mixers are capable of mixing material components of similar viscosity during continuous dosing by swirling. Generally, only material systems that allow a generous deviation in the mixing ratio and react comparatively slowly can be used, which prevents reaction material from already collecting in the mixing tube and possibly clogging it.

### **Material preparation begins with stirring**

The material is conditioned according to the specific application requirements in the single- or double-walled material pressure tanks. Depending on the material system, it may be necessary to selectively load the A-component with air, for example in order to obtain a fine-cell foam, or – just the opposite – to degas it for bubble-free clear potting. The agitator therefore has the function of not only counteracting sedimentation, but also of ensuring uniform air loading or degassing and temperature distribution.

### **Precise refilling for a continuous supply of material**

When used in fully automatic manufacturing processes, automatic refilling stations ensure material-specific preparation, homogeneous consistency and a continuous supply of materials to the component containers of the mixing and dosing system. Partially equipped with an automatic lifting device for more operating convenience and increased occupational and system safety. Production interruptions are therefore a thing of the past.

### **Equipment used to increase process and dosing accuracy**

For the SONDERHOFF SMART dosing cell with DM 50x technology, additional equipment options can be ordered that further increase the process and dosing accuracy, such as the AIR-CLEAN pneumatic nozzle cleaning system, the NOZZLE-CONTROL nozzle measuring device that checks the correct mixing head position, the WEIGHT-CONTROL dosing weight control, the Peltier mixing head cooling system, the LBM 3 air loading measuring and control device as well as the sensor mounted on the mixing head for component identification.



## Mixing Heads of the MK 800 Family

2-/3-component mixing head with dynamic mixing and high-pressure water rinsing

Page 12



## Dosing Machine Cabinet

Extremely precise dosing components for user-friendly maintenance

Page 16



## Material Pressure Tanks

Material conditioning according to a system

Page 18



## Optional Extensions

Equipment used to increase process and dosing accuracy

Page 20

# The MK 800 PRO

Sensor-controlled 2-/3-component mixing head with high-pressure water rinsing, dynamic mixing and sensor-monitored needle position of the dosing valve

In the mixing head, the components are mixed dynamically and the liquid sealant material system is dosed in precise quantities. All mixing heads are also available with stub lines.

Each of the process steps involved has its own specific requirements, which show how good a machine actually is. Our experience acquired over decades of machine development makes the difference and ensures the reliability of our machines.

### Dynamic mixing makes the difference

The greatest possible level of material homogeneity after mixing 2-component material systems with different viscosities – even in the case of demanding, asymmetrical mixing ratios – can only be achieved with dynamic mixing.

The dynamic mixing head enables dosing from 0.2 to 100 g/s with continuously adjustable mixing ratios from 100 : 1 to 1 : 100 and a dosing accuracy of  $\pm 1\%$ . In the case of fast-reacting material, the mixing chamber can also be rinsed regularly – in the case of the MK 800 series with the patented high-pressure water rinsing process!

### Better Results – More Efficient Processes

Our “Formed-In-Place” process, or FIP technology for short, i.e. the application of liquid reactive material systems, makes it possible to automate production steps and design processes to suit individual customers. As experts in FIP technology, we achieve the highest accuracy and reproducible quality by combining the processing components of the Sonderhoff equipment portfolio - resulting in highly efficient processes for our customers.



MK 800 PRO precision mixing head for 3 material components

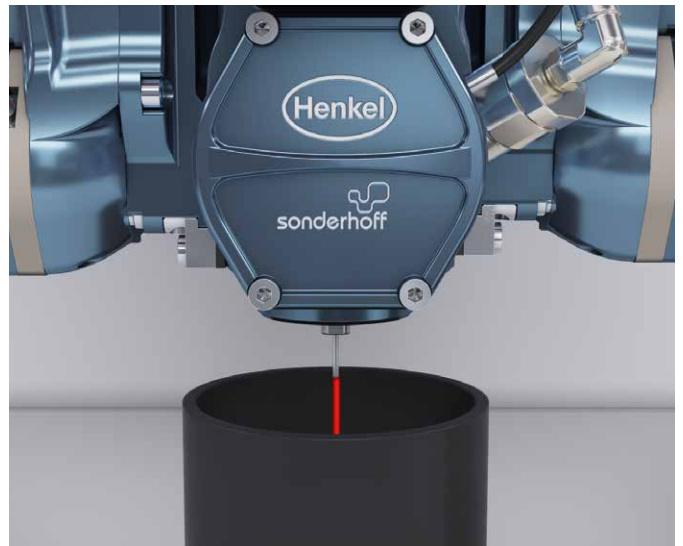

Filling shot with 2K PU foam system FERMAPOR K31. First, the mixing chamber is filled with both components and stirring is started. The dosed application starts after the filling shot.

## DESCRIPTION

- Sensor-controlled 2-/3-component mixing head with high-pressure water rinsing and dynamic mixing for liquid to highly viscous polymeric reaction materials used for seal foaming, bonding and potting
- High-pressure water rinsing for ecological cleaning of the mixing system using high-pressure needle valves for rinsing water injection
- Alternative component rinsing (for the use of non-reactive components)
- Servopneumatically and hydromechanically controlled precision recirculation valves for precise dosing
- Can also be equipped with stub lines for bonding or potting applications
- Weight-reduced construction of a modular design, blue-gray anodized
- Direct stack injection of the components
- Size-optimized, functional V design to increase the degrees of freedom
- Robust and maintenance-free design made of high-strength aluminum alloy and chrome steel
- Electronically adjustable mixer speed
- Special mixer design enables gentle material mixing
- Blowing air needle valve for drying the mixing system
- Low-drip, low-maintenance nozzle shut-off system STOP-DROP NSS 3
- Stroke adjustment is automatically adjusted via the control system
- Sensor-monitored axial position of the agitator shaft
- Material pressure measurement on the dosing valve
- Mixing chamber temperature sensor
- Sensor-monitored needle position of the dosing valve

## TECHNICAL DATA\*

	MK 800 PRO	MK 825 PRO
<b>Dimensions (H x B x D) 2K mixing head</b>	272 x 204 x 150 mm	272 x 204 x 150 mm
<b>Dimensions (H x B x D) 3K mixing head</b>	272 x 204 x 202 mm	272 x 204 x 202 mm
<b>Operating pressure</b>	up to approx. 20 bar	up to approx. 20 bar
<b>Discharge rate</b>	3.0 to 100 g/s	0.2 to 3.0 g/s
<b>Dispense Accuracy</b>	±1 %	±1 %
<b>Mixing head weight for 2 components</b>	approx. 5.5 kg	approx. 5.5 kg
<b>Mixing head weight for 3 components</b>	approx. 6.7 kg	approx. 6.7 kg
<b>Mixing ratio</b>	of 100 : 1 to 1 : 100 continuously adjustable	
<b>Selectable mixer speed</b>	continuously adjustable from 1 – 6,000 rpm	

\* Depending on the mixing ratios, material viscosities and the adaptation of pumps, hoses and mixing elements.

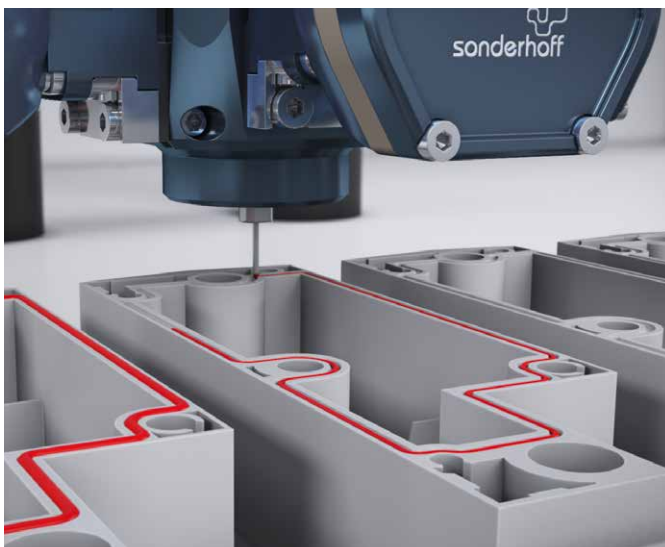

Contour-accurate dosed application of 2-component PU sealing foam via the MK 800 PRO onto the component

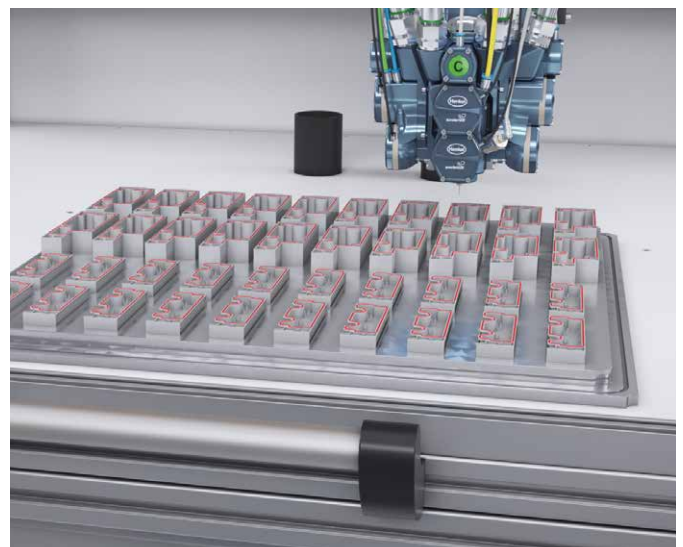

# The New Mixing Heads of the MK 800 Family

Many improvements – one aim: maximum precision

OPTIONS	IMPROVEMENTS
Mixing chamber temperature sensor	Unchanged
Mixing head cooling system by means of a Peltier module (mixing chamber & intermediate housing)	<p><b>NEW!</b> Own circuit instead of split circuit <b>Benefit: easier to maintain</b></p>
Mixing head temperature control by means of temperature control unit (mixing chamber/intermediate housing)	<p><b>NEW!</b> Temperature control additionally also for intermediate housing instead of only the mixing chamber <b>Benefit: Higher efficiency</b></p>
Manual stroke adjustment by means of adjusting wheel	<p><b>NEW!</b> Via adjusting wheel instead of with feeler gauge <b>Benefit: Improved adjustability</b></p>
Automatic stroke adjustment by means of stepper motor	<p><b>NEW!</b> Stepper motor <b>Benefit: Fully automatic adjustment</b></p>
Sensor-monitored axial position of the agitator shaft	<p><b>NEW!</b> Detects whether the mixing chamber, agitator and nozzle are installed correctly, Detects signs of wear <b>Benefit: preventive maintenance</b></p>
Recirculation valve with manual pressure adjustment/manual pressure regulator	<p><b>NEW!</b> Manual pressure regulator instead of preloading screw on the valve <b>Benefit: Improved adjustability</b></p>
Recirculation valve with automatic pressure adjustment/electronic pressure regulator	Unchanged: Electronic pressure regulator
Version with stub valve	Unchanged
Material pressure measurement directly on the valve	<p><b>NEW!</b> In the BASIC version (unchanged from PLUS and up)</p>
Needle stroke measurement on the dosing and recirculation valve	<p><b>NEW!</b> Documents I/O functionality of the valve and signs of wear, if applicable <b>Benefit: preventive maintenance</b></p>



**MK 800 BASIC**

**MK 800 PLUS**

**MK 800 PRO**

●

●

●

●

●

●

●

●

●

●

●

●

●

●

●

●

●

●

●

●

●

● Standard equipment

● Optional equipment

# Dosing Machine Cabinet

Extremely precise dosing components for user-friendly maintenance

The dosing machine cabinet is a compact, self-contained unit that contains all the components essential for the dosing process: the precision gear pumps with servo drive for dosing the material components, the high-pressure water unit for rinsing the mixing head, the Peltier cooling unit for temperature control of the mixing head and the recirculation hoses, as well as the LBM 3 air load measuring unit and the compressed air dryer. Only 2 screws need to be loosened to replace the pumps and drive train. Direct access for pump head removal is available through the side service door.

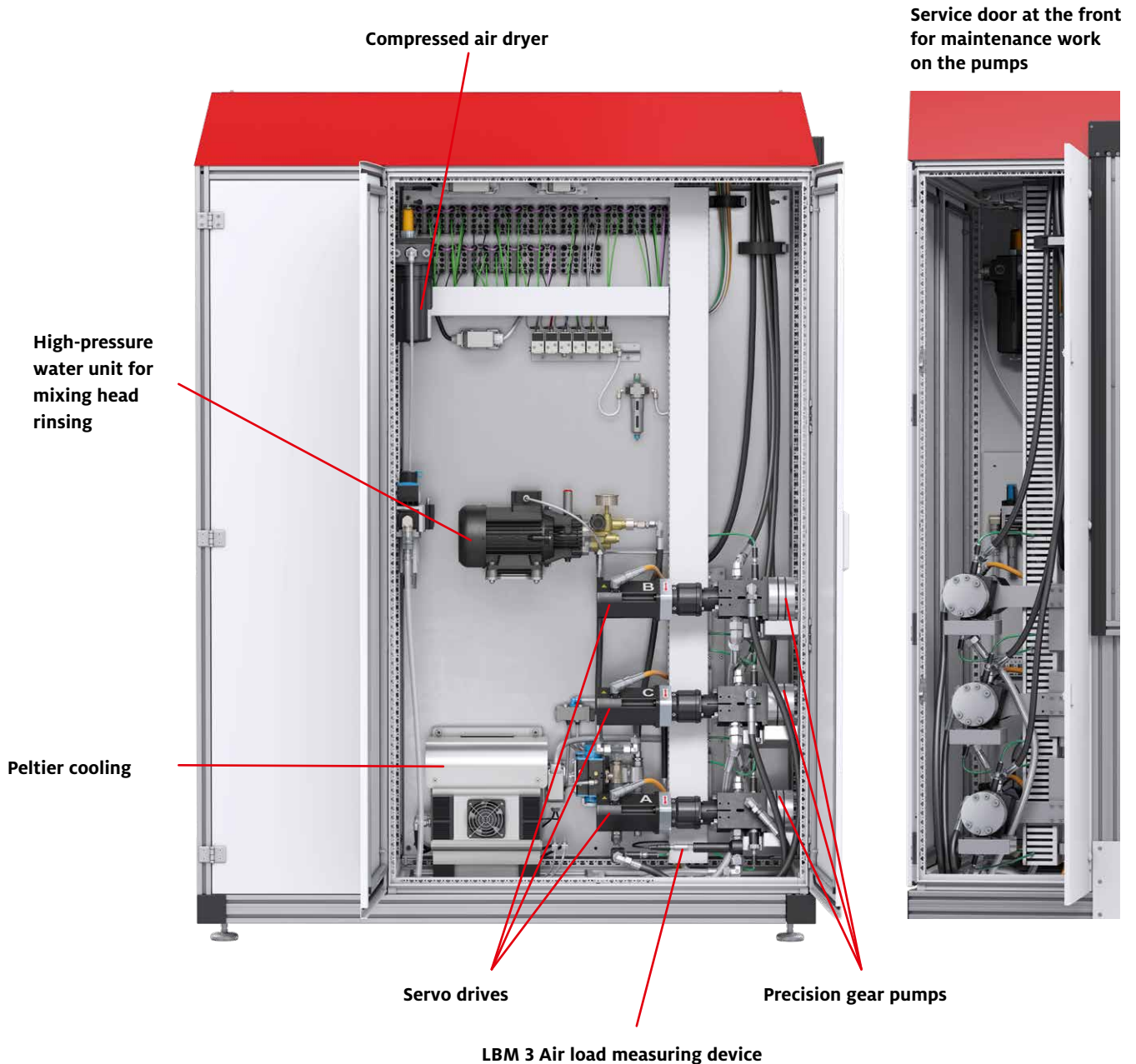



## GENERAL

- Chassis: modular hybrid structure, painted in RAL 7035
- Pressure control for adjusting the recirculation pressure
- Pressure monitoring of the components, optional digital component pressure display for air loading control
- LBM 3 measuring and control unit for air loading
- Application rate: from 0.2 to 100 g/s, other application rates on request
- Mixing ratio: from 100 : 1 to 1 : 100, continuously adjustable
- Viscosity processing range: from 50 to 2,000,000 mPas, other viscosities on request
- Material supply monitoring for component pumps
- Compressed air dryer
- Rinsing and filling shot container

## SPECIFICATIONS

### PRECISION GEAR PUMPS (optionally)

- For FIPFG sealing foam, size: 0.05 / 0.10 / 0.30 / 0.40 / 0.75 / 3.0 / 12.0 ccm/rev.
- For potting/adhesive applications, size: 0.05 / 0.10 / 0.30 / 0.60 / 1.20 / 3.0 / 6.0 / 10.0 ccm/rev.
- Special pumps on request

### DRIVE TECHNOLOGY

- Driving power of the pumps: 1.01 kW
- Driving power of the mixing head: 1.01 kW
- Driving speed of the pumps: 1 - 400 rpm
- Driving speed of the mixing head: 1 - 6,000 rpm
- Speed-controlled servo gear motor with speed display and adjustment on the display

### HOSE PACKAGE

- Length according to customer requirement with all electrical and pneumatic connections
- A component: Fabric-reinforced polyester high-pressure hose
- B component: Steel-reinforced Teflon high-pressure hose

### PNEUMATICS

- Pneumatic system with filter pressure reducer, maintenance unit with pressure monitoring and valve cluster for controlling the pneumatic consumers

### CONNECTED LOADS

- Compressed air connection value: approx. 150 l/min at 6 -7 bar
- Water connection value: approx. 13 l/min for at least 4 bar pneumatic consumers

### DIMENSIONS

- Dosing machine cabinet: B x H x D 1,210 x 2,000 x 510 mm (without frame, feet or carrying eyes), approx. 300 kg

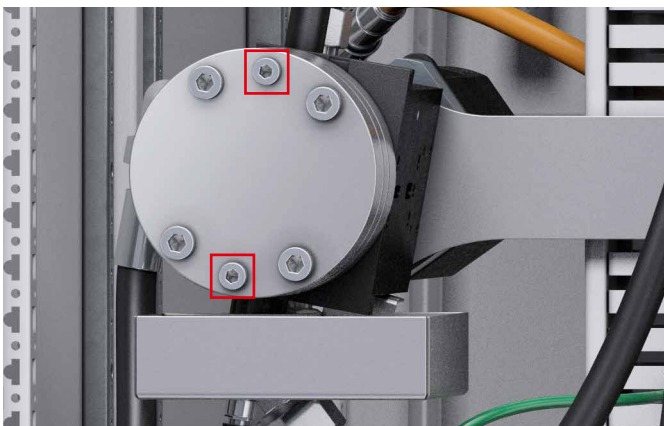

In order to remove the pump, only 2 screws need to be loosened.

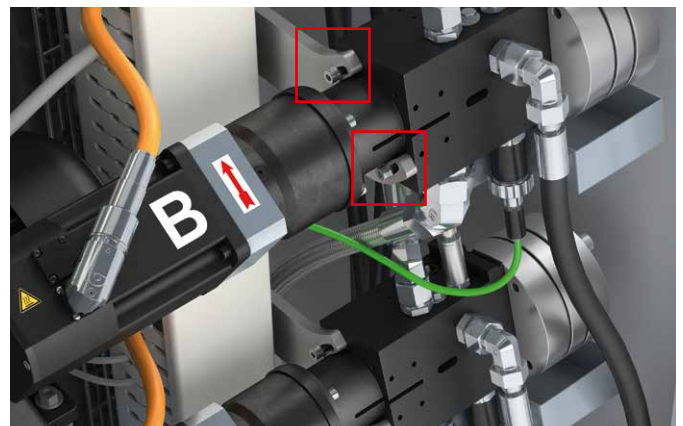

In order to remove the pump including the drive train, only 2 screws need to be loosened.

# Material Pressure Tanks

## Material conditioning according to a system

Material preparation of the 2C reaction materials used for seal foaming, bonding and potting, e.g. air loading for seal foaming or degassing for bubble-free potting, takes place in the material pressure tanks. Two or three pressure tanks are available, depending on the configuration of the SONDERHOFF SMART dosing cell. The material pressure tanks are equipped with various sensors that indicate whether the pressure tank is empty or needs to be refilled and also include an overfill protection as a safety feature. This is important when the material pressure tanks are filled automatically by a refilling station.

The material components are fed from the material pressure tanks through the recirculation lines to the mixing head by means of precision gear pumps, where they are thoroughly mixed and then applied to the component via the dosing nozzle.

Material temperature control plays a major role in many material systems. It is achieved by means of heating sleeves or double-walled material tanks. Furthermore, the material temperature can also be kept constant throughout the material circuit by means of an optional hose temperature control system.

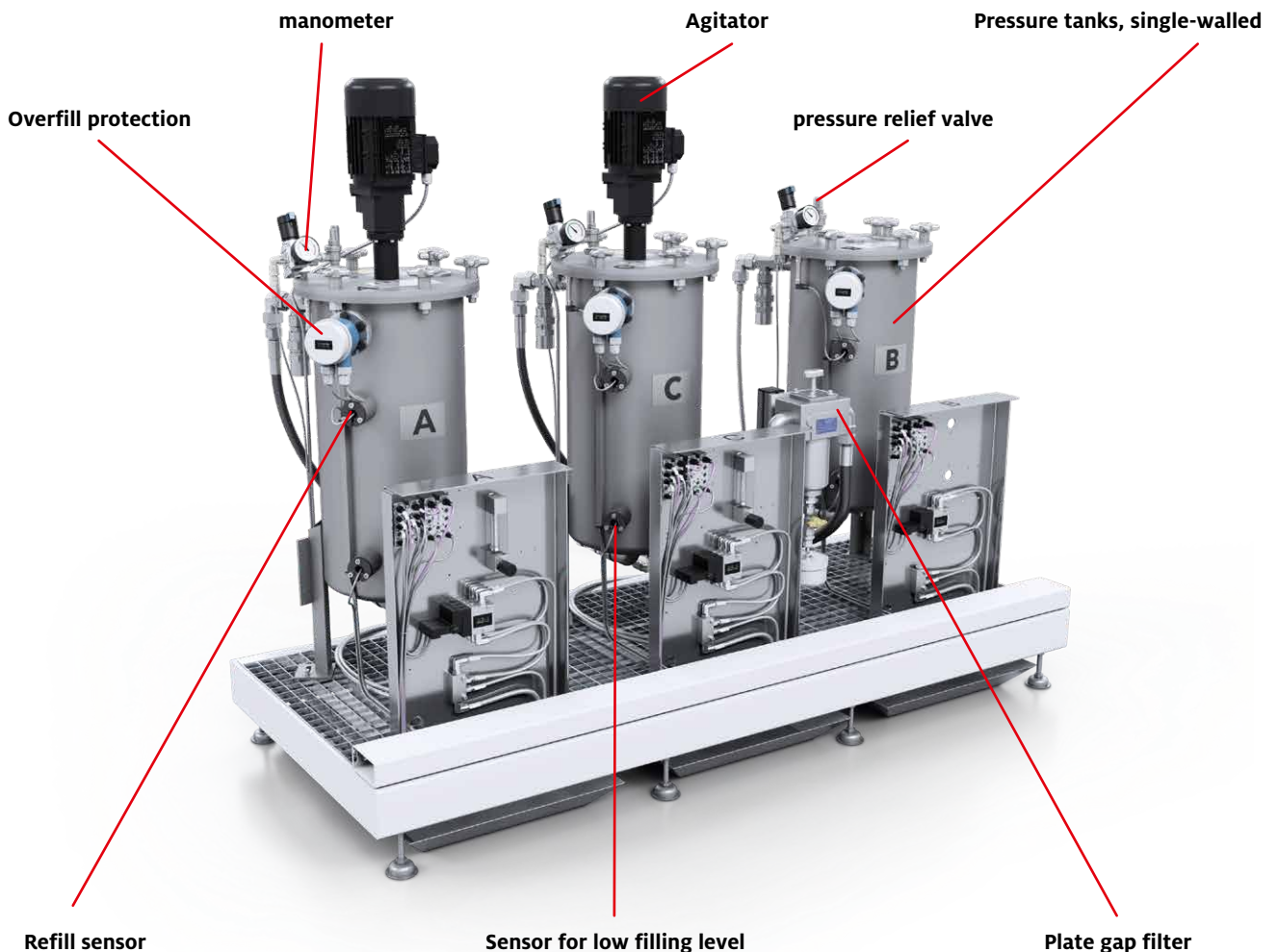

## DESCRIPTION

- Material pressure tank with capacitive minimum fill-level sensors, safety pressure valve (TÜV type-tested), overfill protection (only in conjunction with the use of a refilling station) and shut-off ball valve, with compressed air fittings and compressed air reducing valves for pre-pressure regulation of the tank pressures
- Material pressure tank, single-walled, chrome-nickel steel in 24 l or 44 l
- Material pressure tank, double-walled, chrome-nickel steel in 24 l, 44 l or 90 l
- Wire mesh filter cartridges and plate gap filters
- Three-phase agitator running at 23 or 96 rpm
- Electric heating for single-walled containers
- Temperature control for double-walled containers
- Automatic air loading
- Manual evacuation
- Preparation for the control of an automatic refilling device
- Material supply through refilling stations for containers from 20 to 1,000 liters
- Recirculation hose package
- Electric heating hoses with steel-reinforced Teflon high-pressure hose core
- Double-walled medium heating hose with Teflon high-pressure hose core
- Container platform: Galvanized grating, with adjustable leveling feet and drip tray, standing separately
- Platform incl. material pressure tank (per component): B x H x D 625 x 1,500 x 860 mm, approx. 85 kg



Double-walled material pressure tank in cross-section with view of air loading and agitator



Single-walled material pressure tank with agitator



Double-walled material pressure tank with temperature control unit for heating and cooling the material



Single-walled material pressure tank with heating jacket

## Automatic refilling stations

### Accurate refilling for a continuous supply of material

When used in fully automated manufacturing processes, automatic refilling stations ensure material-specific preparation, homogeneous consistency and a continuous supply of materials to the component containers of the mixing and dosing system – without exposure or contamination of the products to be filled. Partially equipped with an automatic lifting device for more operating convenience and greater occupational and system safety. Production interruptions are therefore a thing of the past.

They are controlled by the mixing and dosing system with the help of monitoring by means of fill-level sensors in the material containers. Controlled agitators with an adjustable speed range and a programmable timer ensure optimum homogenization of the reactive materials. All refilling stations can be equipped with different stirring elements, depending on the material. Existing production plants can be retrofitted.



#### **BIG ELEVATOR**

**Automatic container refilling station with lifting device and controlled agitator for liquid and thixotropic products (e.g. polyols)**



#### **ELEVATOR**

**Automatic drum refilling station with lifting device and controlled agitator for liquid and thixotropic products (e.g. polyols)**

## DESCRIPTION

- Column with drum lid lift, or alternatively with pump holder (ELEVATOR models)
- The drum lid lifting device is moved pneumatically. (ELEVATOR models)
- Optional material conditioning by means of an electric geared agitator with agitator shaft and agitator blade
- Agitator programming with clock timer built into the switch cabinet of the refilling station
- Pneumatic piston pumps or diaphragm pumps, adaptable
- Hose package for connection to the mixing and dosing system
- Drip tray with grating (option)

## SPECIFICATIONS

<b>Paint coating</b>	2C textured paint RAL 7035 (light gray) / RAL 3020 (red)
<b>Piston pump ratio</b>	from 5 : 1 to 10 : 1 / from 20 : 1 to 61 : 1 (for the drum pumping station SONDERHOFF FPS)
<b>Agitator speed</b>	With the unregulated version: 23 rpm at 0.18 kW With the regulated version: 20 – 150 rpm at 1.5 kW; alternatively: 30 – 300 rpm at 3.0 kW
<b>Connected load of the agitator</b>	3 x 400 V, 50 Hz or 60 Hz, TN network
<b>Electric version consumption</b>	Design according to EN 60 204-1 approx. 0.25 to 1 kVA
<b>Compressed air connection value</b>	approx. 450 l/min at 5 bar
<b>Hose package length</b>	approx. 5 m

## VARIANTS

<b>BIG ELEVATOR</b>	Automatic container refilling station with agitator (0.18 kW), unregulated, without pump; Automatic container refilling station with agitator (1.5 kW or 3 kW), regulated, without pump
<b>ELEVATOR</b>	Automatic drum refilling station with agitator (0.18 kW), unregulated, with piston pump; Automatic drum refilling station with agitator (1.5 or 3 kW), regulated, with piston pump
<b>SUPPLY TAP</b>	Automatic drum refilling station with piston or diaphragm pump
<b>FPS</b>	Automatic drum pumping station (ram press) for 30 to 200-liter containers, with scoop piston pump as two column lifter



### SUPPLY TAP

Automatic drum refilling station for low-viscosity products (e.g. isocyanates)



### FPS

Automatic drum pumping station for 30 to 200-liter containers, with scoop piston pump as two column lifter for high-viscosity / paste-like materials

## Optional Extensions

### Equipment used to increase process and dosing accuracy

Additional equipment options can be ordered for the SONDERHOFF SMART dosing cell with 50x technology, which further increase process and dosing accuracy.

The use of the patented high-pressure water rinsing technology for the mixing chamber results in advantages in terms of quality and economy. This is because, in contrast to conventional solvent-based cleaning of the mixing chamber, where the solvents that are used have to be disposed of, high-pressure water rinsing uses tap water that is discharged into the regular wastewater system after use, which saves disposal costs.

The intervals for hot PU cleaning in the HOT-CLEANER are determined according to the intensity with which the mixing elements of the dosing cell are used.

The pneumatic AIR-CLEAN nozzle cleaning system ensures that the dosing nozzle of the mixing head is always clean. The intervals of this cleaning function are freely adjustable in the control system of the mixing and dosing systems.

The NOZZLE-CONTROL nozzle measuring unit uses two laser sensors positioned at right angles to check the presence and the exact positioning of the mixing head nozzle, as well as whether material is adhering to the nozzle. If the nozzle lies outside the tolerances, a signal tone accompanied by an error message is emitted. In such a case,

the operator checks the dosing nozzle and renews it, if necessary. By means of the WEIGHT-CONTROL dosing weight control with a calibrated electronic scale, the constant discharge quantity of the mixing head dosing process is compared to the target value in the dosing program. The repeatedly accurate application rate is an important criterion for the dosing accuracy.

The component identification sensor mounted on the mixing head detects the presence of the component and transmits the information to the control system.

The combination of high process and dosing accuracy, a constant travel speed of the mixing head and precise control of the repeatedly accurate start and end of the dosing process ensures high seal quality.

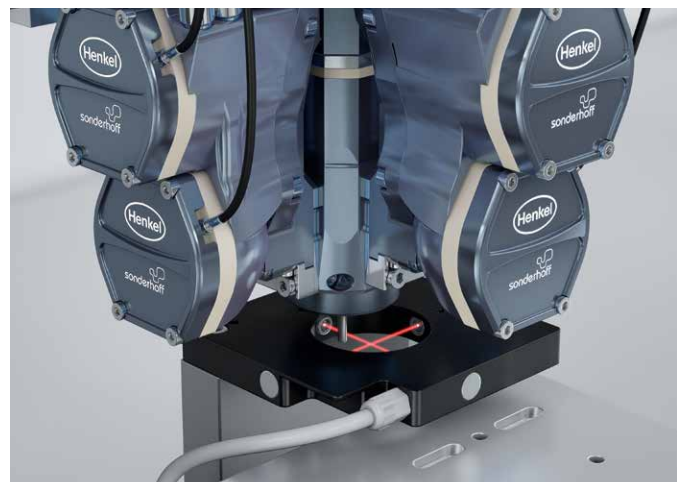

The NOZZLE-CONTROL laser-based nozzle measuring unit checks that the dosing nozzle is in the correct position and there is no contamination



Sensor for component identification

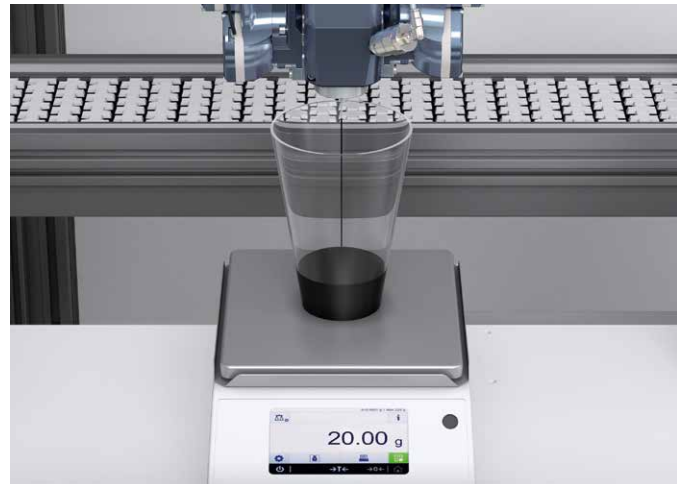

WEIGHT-CONTROL dosing weight control for checking the discharge quantity



The pneumatic AIR-CLEAN nozzle cleaning system (left) and the device for high-pressure water rinsing (right)

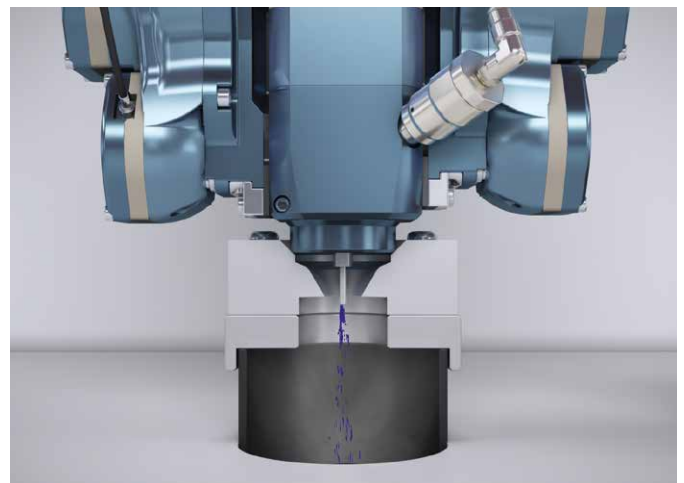

AIR-CLEAN in use – the air flow tears material residues off the nozzle tip

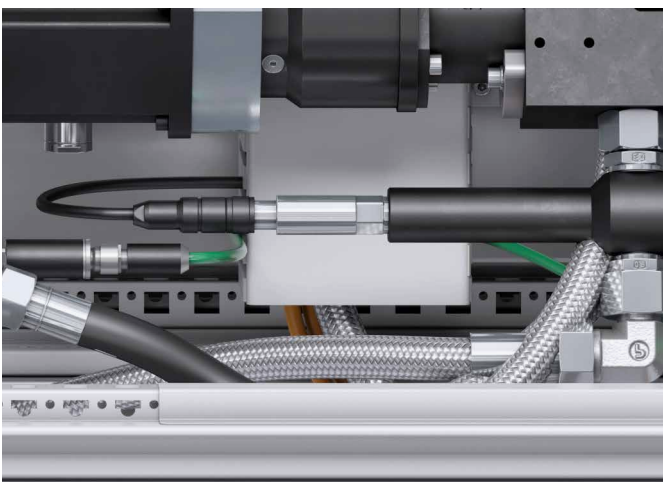

LBM 3 air load measuring unit



HOT-CLEANER: Electrically heatable container for cleaning the mixing elements with PU hot cleaner

# CONTROL AND MONITORING

## **Control cabinet**

Page 28

## **Mobile panel and operating panel**

Page 30

## **Visualization of the user interfaces**

Page 32







# Control and Monitoring

## Broad Data Basis for Optimized Process Evaluation and Control

The sensors installed in the SMART dosing cell and the MK 800 PRO mixing head determine a wide range of data for uninterrupted monitoring of and compliance with critical process parameters, such as the temperature, the degree of air loading, the axial position of the agitator shaft as well as the needle positioning in the dosing valve.

The machine operator therefore has access to a comprehensive database that covers the entire application process. This enables fast and precise data analysis for optimized process evaluation and control, as well as predictive monitoring of the material application processes and the preventive maintenance of wearing parts.

### **Control cabinet: The expandable future-proof control center**

The control cabinet is the expandable future-proof control center of the SONDERHOFF SMART dosing cell with DM 50x technology. It contains the control components and includes the electrical distribution system and the control and safety technology and protects them against malfunctions and mechanical damage.

The FIPFG sealing technology has been used in switch cabinet engineering for sealing for years. The switch cabinets we use are seamlessly sealed with the polyurethane sealing foams from the FERMAPOR K31 product family in accordance with the switchgear standard DIN EN 61439, so that neither dust nor moisture can enter.

### **Mobile panel and operating panel as human machine interface (HMI)**

The standard version of the SMART dosing cell is operated with the multi-function MP 2 mobile panel with 10.1-inch touchscreen. It is portable, which makes it easier to program the component contours. The 21.5-inch CONTROL 2 multi-touch operating panel is offered as an optional extra. The graphic user interfaces continuously provide information on the performance status of the system and the process data that have been recorded by the sensors. A user-friendly menu layout with central navigation enables intuitive menu navigation.



## Control cabinet

The expandable future-proof control center

Page 28

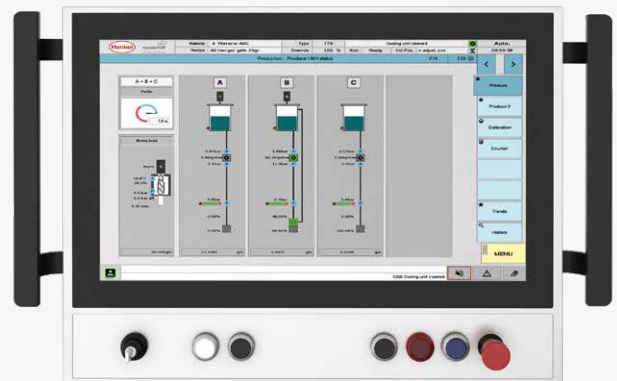

## CONTROL 2 Operating Panel

The optional CONTROL 2 multi-touch operating panel (21.5") facilitates easy operation of the dosing cell

Page 30



## MP 2 Mobile Panel

The multifunctional MP 2 mobile panel (WXGA TFT) with 10.1" touchscreen simplifies the dosing program of the component contours.

Page 30

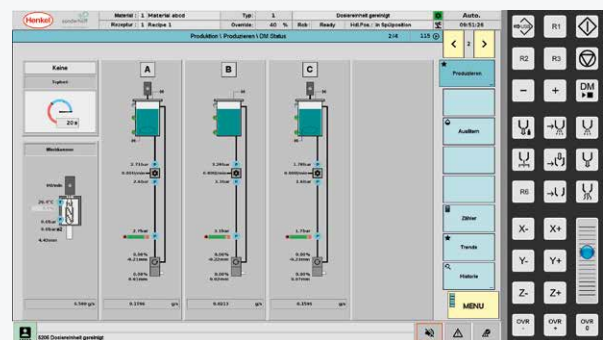

## Visualization

The visualizations on the user interfaces provide information about the performance status of the dosing cell and the status of the processing

Page 32

# Control cabinet

## The expandable future-proof control center

Scalable, high-quality and durable control components from well-known manufacturers are installed in a protected form in a high-quality brand-name switch cabinet. Inside, the switch cabinet offers enough space for future expansions. The easy-to-use special mounting plug-in system enables the addition of further control components. This ensures a high degree of flexibility in case changes need to be carried out in the future.

### **Servo motors and servo controllers -- higher resolution and precise path behavior**

The digital EnDat encoders of the servo motors enable very precise path behavior of the servo axes when the mixing head is moved. The use of an electronic nameplate in the servo motor offers the advantage of automatic parameterization of the servo controller to the current parameters of the connected motor. Thanks to the absolute encoders used, the servo axes of the linear robot are immediately ready for use after the control system has been started up. An improved mounting system makes it easy to connect single and dual controllers – during servicing, the servo controllers can then be exchanged very easily. The power supply of several servo controllers is provided by a central module, which also handles the communication of the control system.

### **New safety features – programmable, simple, fast**

The SONDERHOFF SMART-L and SMART-M dosing cells with DM 50x technology prioritize occupational safety. Through the use of the latest integrated safety logic, safety functions such as safety gate switches or optional light grids, safety shutoff mats or more complex safety functions, e.g. SLS (Safely Limited Speed), can be implemented. And the new safety technology also takes up less space in the switch cabinet of both dosing cells. With the programmable safety logic, adjustments to the safety function can now be implemented much more easily and faster. The safety functions of the linear robot's servo axes are fully integrated into the safety logic and can therefore also respond very quickly to safety events.



Switch cabinet with optional roof air conditioning for ambient temperatures above +25 °C

## DESCRIPTION

- Modular IPC control system in the switch cabinet with Powerlink
- EMERGENCY STOP function with proven safety concept, realtime capable bus system
- Switch cabinet offers plug-in connections to plant modules (dosing machine, CNC linear robots, pressure tanks, etc.)
- Protective door safety switch off with guard locking (optional when delivered with a protective fence)
- Set-up and alarm logging, process data logging
- Strand identification
- Switch cabinet lighting
- Operating hours meter
- Remote maintenance via VPN router
- Voltage adjustment to external voltages, 60 Hz version
- Air conditioning unit for switch cabinet temperature control
- Open peripheral interface
- Central control of additional peripherals/automation possible
- Data backup by means of USB stick or LAN
- Data storage for operating system and system programs
- Electrical system: Design according to EN 60 204-1
- Power supply: 3 x 400 V, 50 Hz or 60 Hz or country-specific adaptation
- Rated power: approx. 10 kVA
- Ø consumption: approx. 4 kVA
- Control cabinet: B x H x D 1,210 x 2,650 x 510 mm, approx. 350 – 450 kg



Servo technology with integrated safety logic and central power supply



Industrial PC from B&R without mechanical wearing parts

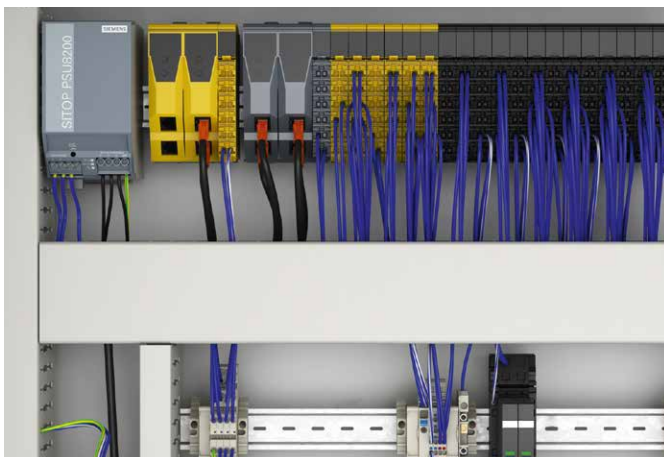

Safe Limited Speed/Safety Modules

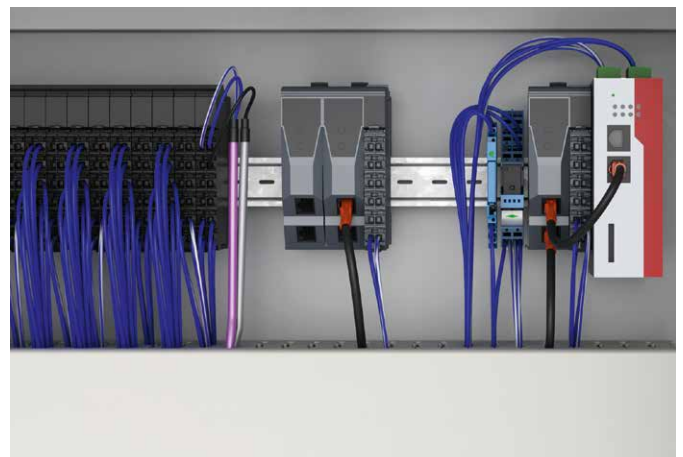

VPN router for remote maintenance (remote collaboration)

## Mobile Panel and Operating Panel

### Convenient Working and Control with Our Human Machine Interface (HMI)

The SONDERHOFF SMART-L and SMART-M series of dosing cells are designed to enable the operator to perform a wide variety of tasks easily and safely. Standard operation is carried out via the easy-to-use, multi-function MP 2 mobile panel (WXGA TFT) with 10.1-inch touchscreen – a significant simplification for the contour programming of components. The CONTROL 2 multi-touch operating panel with the 21.5-inch user interface is available as an optional extra.

The presetting and regulation of all machine and process parameters ensures that the production sequence of the machine is fully automatic. In addition, the sensor system installed in the dosing machine continuously supplies measurement data on the factors influencing the production process, which can be prognostically evaluated and proactively readjusted. The automatic logging of all system, material and process data also ensures the transparency of the previous production sequence at any time.



SONDERHOFF SMART-L dosing cell with a lifting door and MP 2 mobile panel on a bracket on the side of the cell and optional CONTROL 2 multi-touch operating panel which can be swiveled to the side

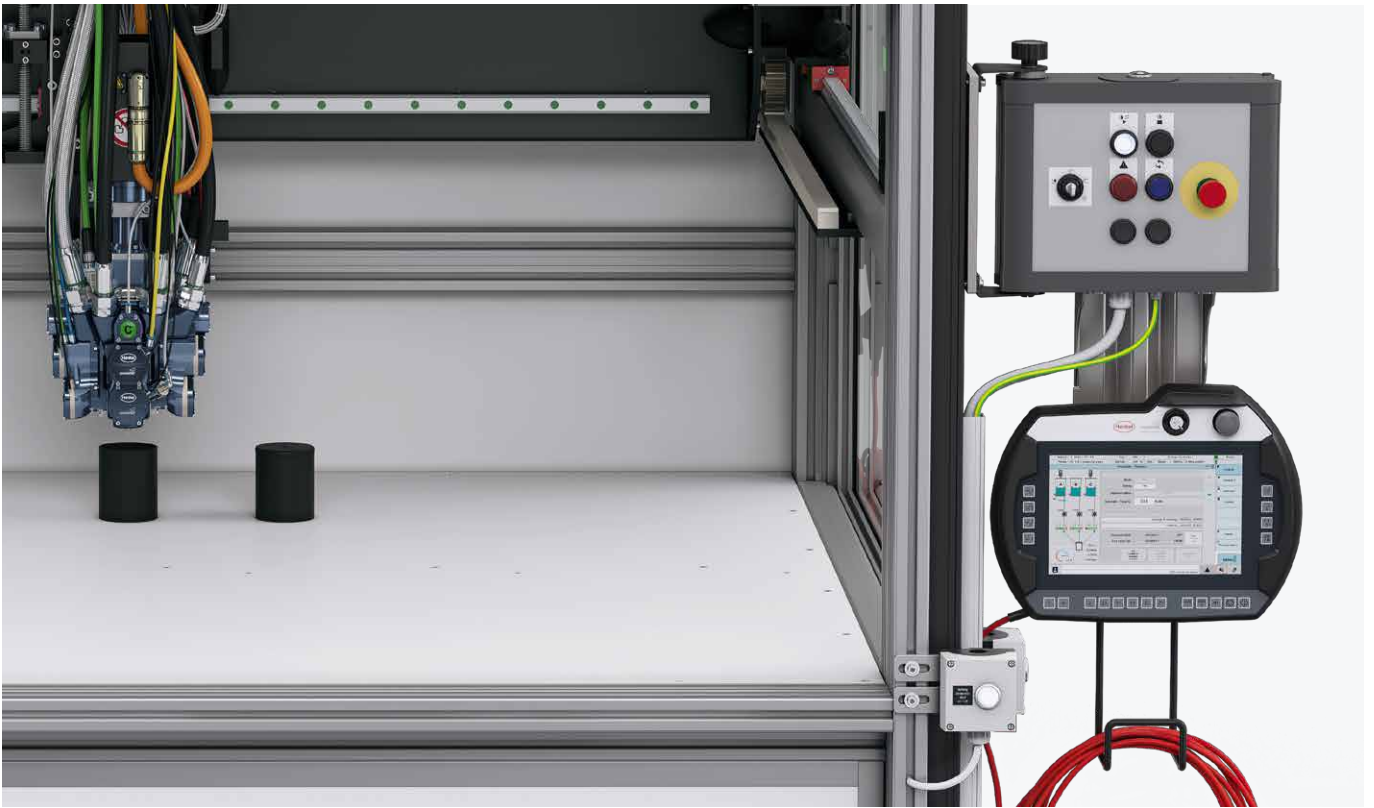

Standard: Multi-function MP 2 mobile panel with 10.1-inch touchscreen with operating mode control panel



Optional: CONTROL 2 multi-touch operating panel, mounted laterally on a swivel arm, with display elements and operating keys, visualization via 21.5" touchscreen. With this option, you also receive the multi-function MP 2 mobile panel.

# Visualization of the user interfaces

## Intuitive system operation and simple evaluation of machine parameters

The visualizations of the data collected by sensors provide continual information about the performance status of the dosing cell and the status of the processing in accordance with the predefined dosing program. Due to the high level of detail of the data, the machine operator can take corrective action with predictive measures and adjust the process parameters of the system whenever necessary. The universally understandable symbols on the mobile panel's user interfaces make it possible to navigate through the menus in any language. The use of color graphics and the grouping of functions in the operating menu help simplify the evaluation of the displayed measurement data information and provide a better general overview. This allows the machine operator to concentrate on the main functions of operation and maintaining the important machine parameters. This ensures smooth production and high product quality.

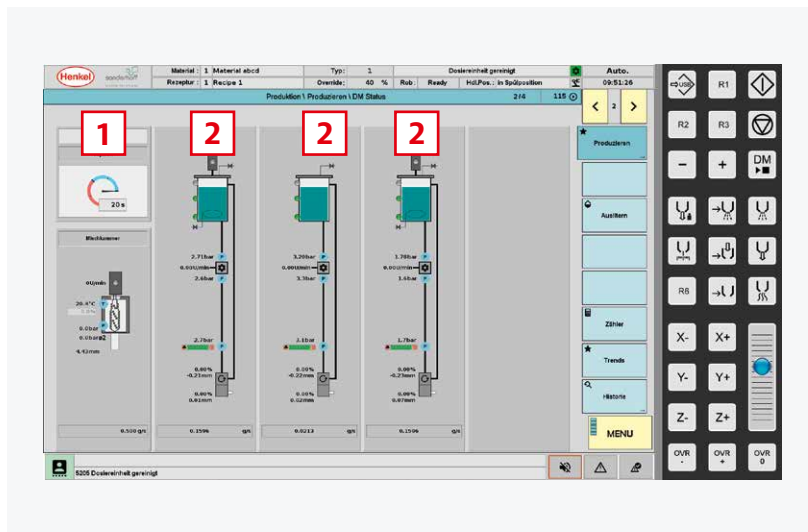

**First column:** Reactivity of the material (pot life in s) for active material components as well as detailed information on the mixing chamber and agitator

**Columns 2–4:** Overview of the three material components, display of the filling level in pressure tank, line pressure upstream of pump, speed of pump, line pressure downstream of pump, component pressure at valve, recirculation control value in %, recirculation valve offset in mm, recirculation status, dosing control value in %, dosing valve offset in mm, current component dosing rate (g/s)

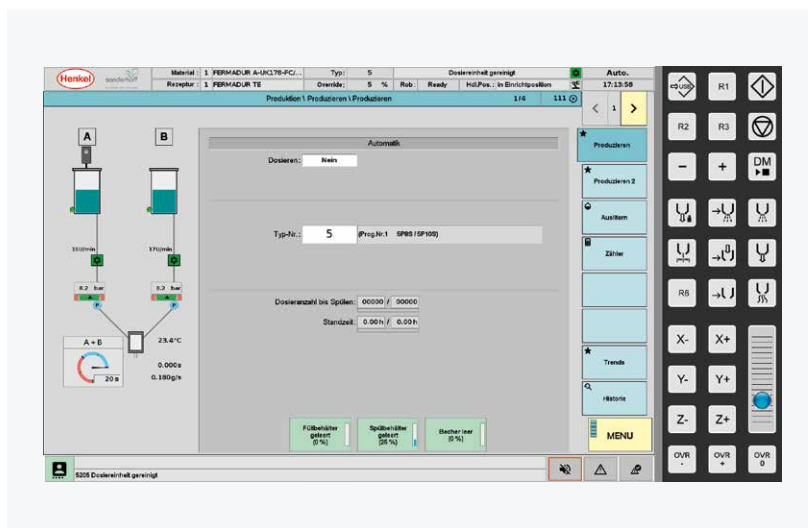

Shows the active material components, the tank level, the pump speed, the line pressure downstream of the pump, the mixing head temperature, the dispensing time (s), the discharge line (g/s) and the reactivity of the material (pot life in s)



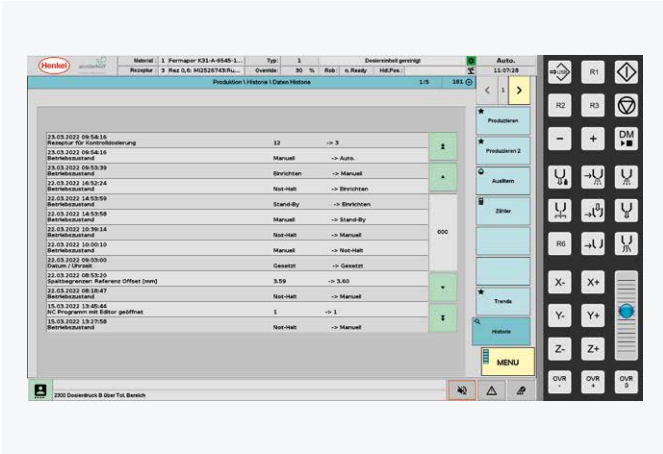

**Data history:**

Display of date, time, information about old value and new value changes

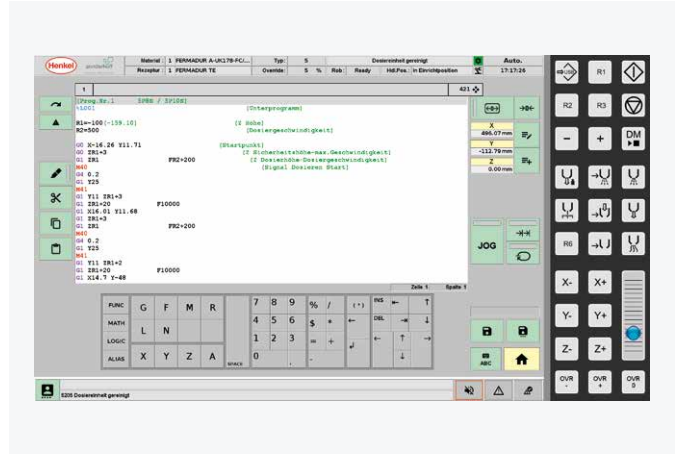

**Editor:**

NC program via keyboard on the touchscreen or external USB keyboard

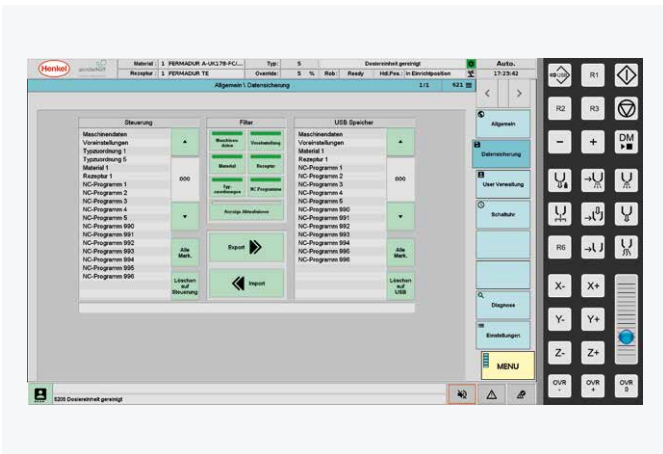

**Data backup:**

Allows selective selection of machine data, presets, type assignment, material, recipe and NC program to be saved

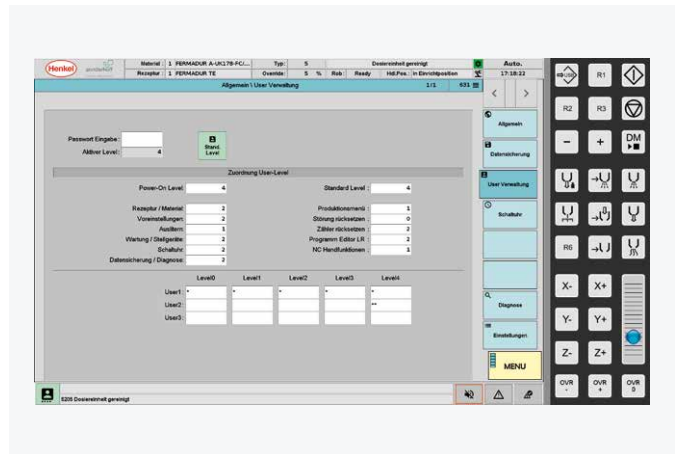

**Password:**

User management for three users with the possibility to configure differentiated access via password levels (0-4)

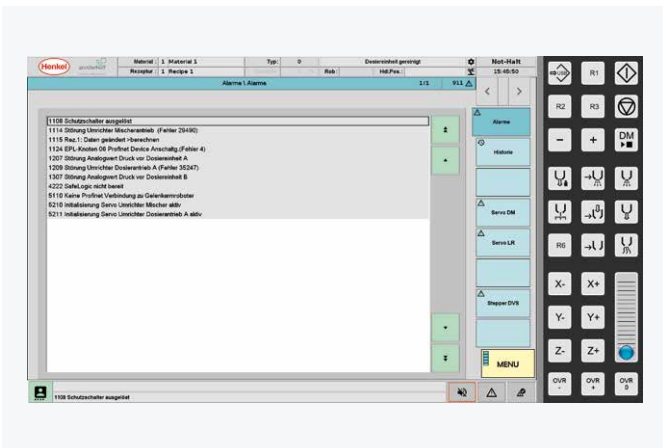

**Alarm messages:**

Display of current alarm messages with alarm code and plain text

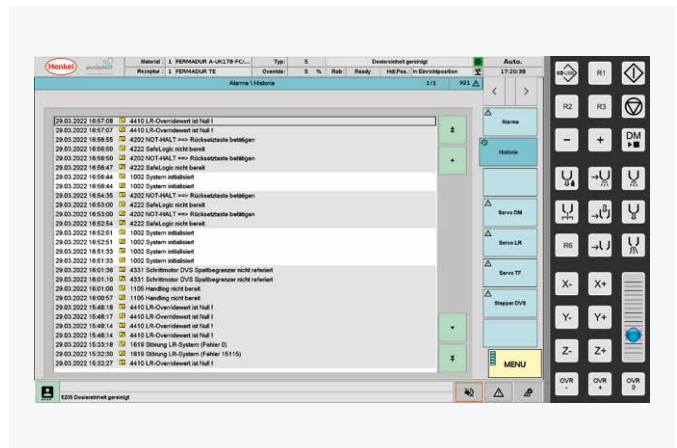

**Alarm history:**

Displays historical alarm messages with date, time, alarm code and plain text, as well as alarm reset status

# VARIANTS AND AUTOMATION

**SMART-L/M dosing cell  
with different travel ranges**  
Page 36

**SMART-L/M dosing cell  
with lifting door (basic version)**  
Page 38

**SMART-M dosing cell  
with rotary indexing table**  
Page 40

**SMART-L dosing cell  
with shuttle/sliding table**  
Page 42

**SMART-L dosing cell  
with transfer belt**  
Page 44



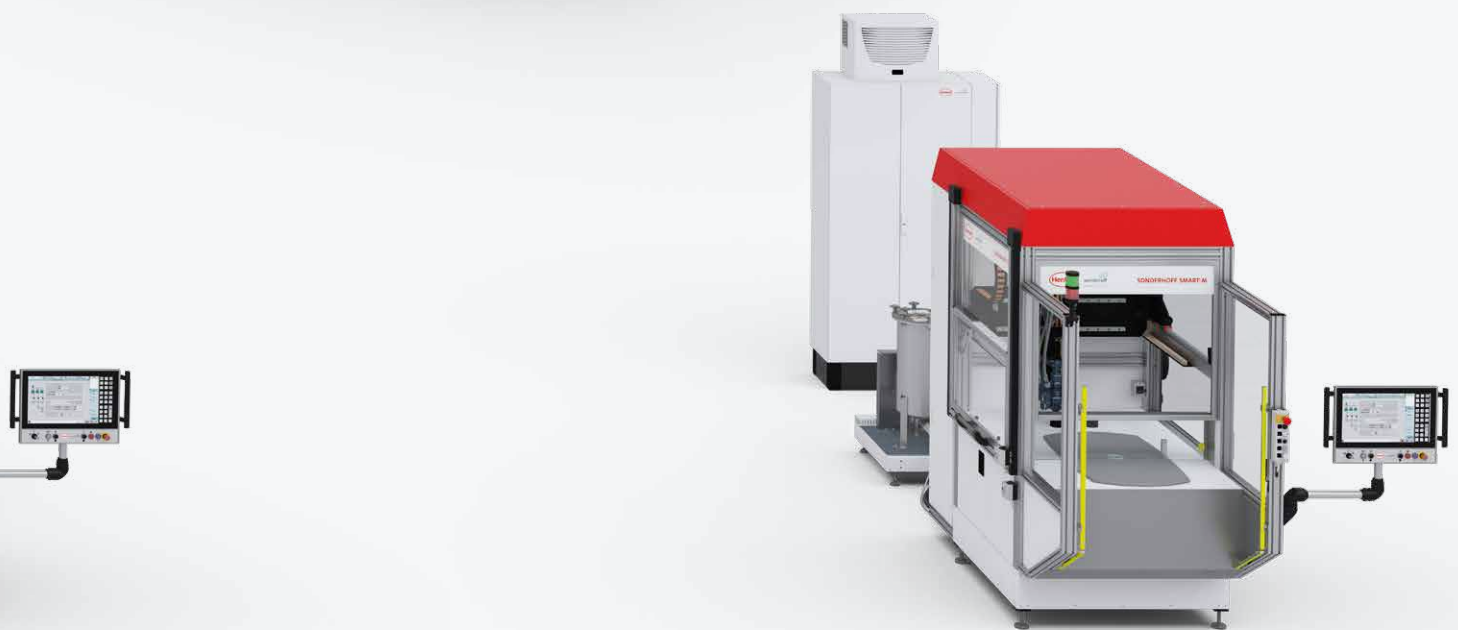
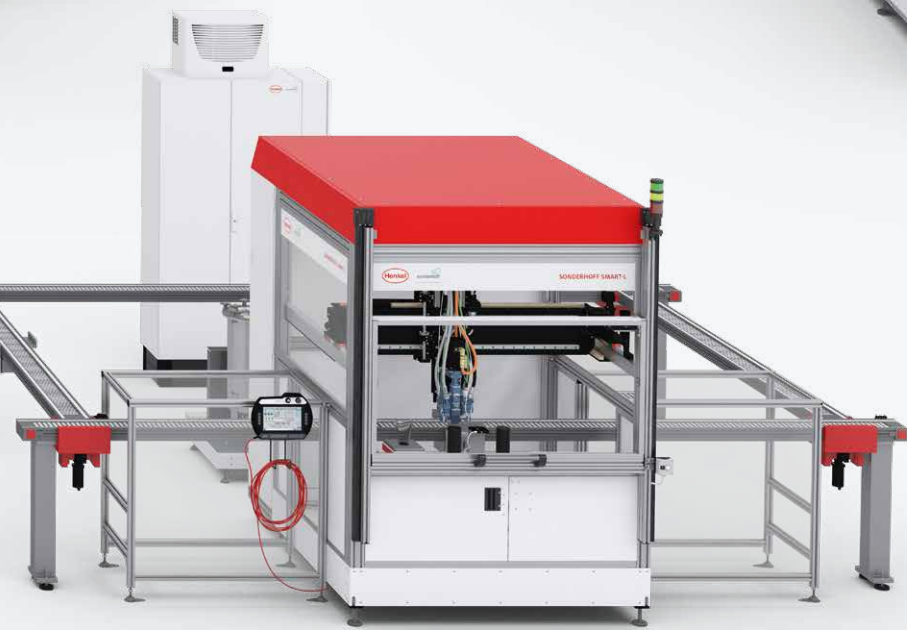

## SONDERHOFF SMART L/M dosing cell with different travel ranges

The precision mixing heads from the MK 800 series, which can be used in the SONDERHOFF SMART-L and SMART-M dosing cells, are accurately guided throughout the different travel ranges of the two cells by a 3-axis linear robot integrated within the cell.

The 3-axis linear robot features high rigidity and acceleration values combined with rapid direction changes. Tight radii and flowing movements over long contours are no problem. This allows the mixing head to be guided over the component being machined with very high repeatability ( $\pm 0.1$  mm).

- Programming and control via dialog input in the menu system using the multi-function MP 2 mobile panel; alternatively with the optionally available CONTROL 2 operating panel.
- Control by means of the IPC control system of the mixing and dosing system
- Guide system with low-wear linear bearings and spindle drive on the Z axis
- Energy guiding chain to accommodate all pneumatic, electric and hydraulic lines





Travel range in the SONDERHOFF SMART-L dosing cell:  
1,000 x 800 x 250 mm (x/y/z)



Travel range in the SONDERHOFF SMART-M dosing cell:  
500 x 600 x 250 mm (x/y/z)

SPECIFICATIONS	SONDERHOFF SMART-L	SONDERHOFF SMART-M
Travel range of the mixing head in the cell (x/y/z in mm)	1,000 x 800 x 250	500 x 600 x 250

SPECIFICATIONS	3-axis linear robot
Max. travel speed	20 m/min.
Max. acceleration	5 m/s <sup>2</sup>
Repetition Accuracy	±0.1 mm

# SONDERHOFF SMART-L/M dosing cells with lifting door

## Features of the basic versions

The standard version of SONDERHOFF SMART-L/M dosing cells are equipped with a lifting door at the front. The components are manually inserted here into the dosing cell for applying sealing foams, adhesives or potting compounds.

The dosing machine cabinet is integrated in the rear wall of the dosing cell. Behind this are the material pressure tanks (24 l or 44 l, single-walled or double-walled) on a grating platform with adjustable leveling feet, incl. drip tray.

Below the inspection lifting door on the side of the dosing cell, on the left, there is the telescopic pull-out to fill the filling shot and rinsing water tanks. For maintenance and servicing, a large swing door on the right side of the dosing cell can be opened 180°.



SONDERHOFF SMART-L dosing cell with lifting door and MK 825 PRO mixing head, configured for two or optionally three material components, as well as material pressure tank at the rear of the cell and switch cabinet for the control system



Large swing door on the side (right) with 180° opening for maintenance and servicing



Dosing machine cabinet integrated in the rear of the cell with hinged doors and material pressure tank (24 l or 44 l, single-walled or double-walled) on grating platform with adjustable leveling feet and drip tray



Inspection lifting door on the side (left)



Lateral telescopic pull-out for refilling filling shot and rinsing water tanks

## SONDERHOFF SMART-M dosing cell with rotary indexing table

Cell insertion area protected by light grid

Components can also be loaded into the SONDERHOFF SMART-M dosing cell for seal foaming, adhesive bonding or potting in a user-friendly manner via a rotary indexing table. It has a 180° pitch for the insertion and working position, and the changeover takes place within a cycle of approx. 1.5 seconds. During semi-automatic component loading with a rotary indexing table, access to the insertion area on the cell is protected by a light grid.



SMART-M dosing cell with trolley for pick & place assembly and storage of the finished components





Rotary indexing table rotates 180° into the dosing position for contour-accurate movement of the component for material application



Mixing head during filling shot in the AIR-CLEAN device



Dosed application of FERMAPOR K31 foam sealant into the groove of the filter frame



**Left Side:** The pneumatic AIR-CLEAN nozzle cleaning system cleans the mixing head nozzle by means of compressed air. **Middle:** Device for high-pressure water rinsing and filling shot station. **Right Side:** The NOZZLE-CONTROL laser-based nozzle measuring unit checks that the dosing nozzle is in the correct position and there is no contamination.

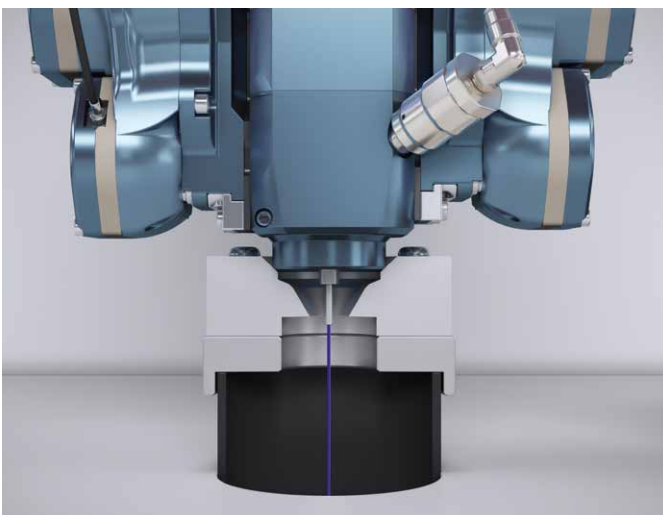

Filling shot position

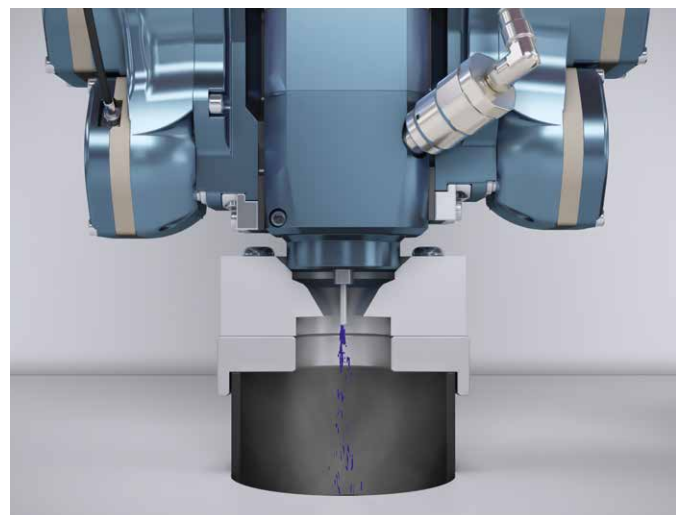

Blowing Position: Compressed air is used to blow off any buildup of material on the dosing nozzle

## SMART-L dosing cell with shuttle/sliding table

### Parts supply and removal via alternating shuttle mode

The SONDERHOFF SMART-L dosing cell can also be loaded with components in a user-friendly manner via an attached, pneumatically driven shuttle/sliding table (compressed air consumption: 120 l/min at approx. 6 bar). With the semi-automatic solution, a machine operator loads the two pick-up plates with the components in an alternating sequence.

The aluminum pick-up plates are prepared with a hole pattern for attaching the workpieces or workpiece fixtures. During dosing, the shuttle tables move alternately into the working area of the cell in continuous shuttle mode along a single level. The insertion area for the components is clearly and safely separated from the travel range of the CNC robots.



SMART-L dosing cell with trolley for pick & place assembly and storage of the finished components

Work surfaces side by side, dimensions of the respective work surface (length x breadth in mm):

DIMENSIONS WORK SURFACE SLIDING TABLE				DIMENSIONS LINEAR ROBOT	
Width (W)	Length (L)	Stroke (S)	Working height (WH)	X-axis	Y-axis
550 (440 usable workspace)	800 (746 usable workspace)	1,500	950	1,000	800

Special sizes can be produced on request.

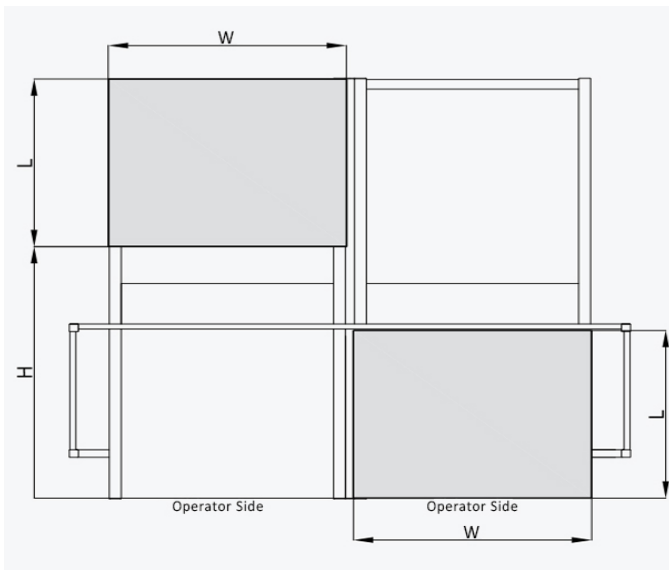

Shuttle table layout

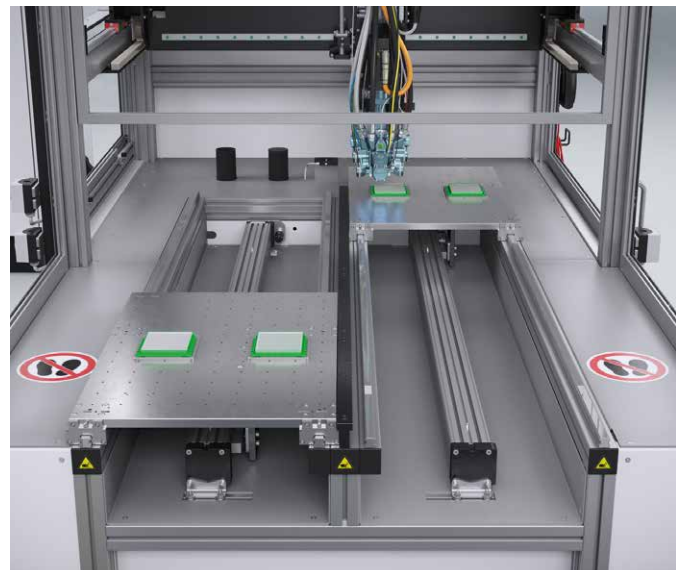

Shuttle table in shuttle mode for parts supply and removal

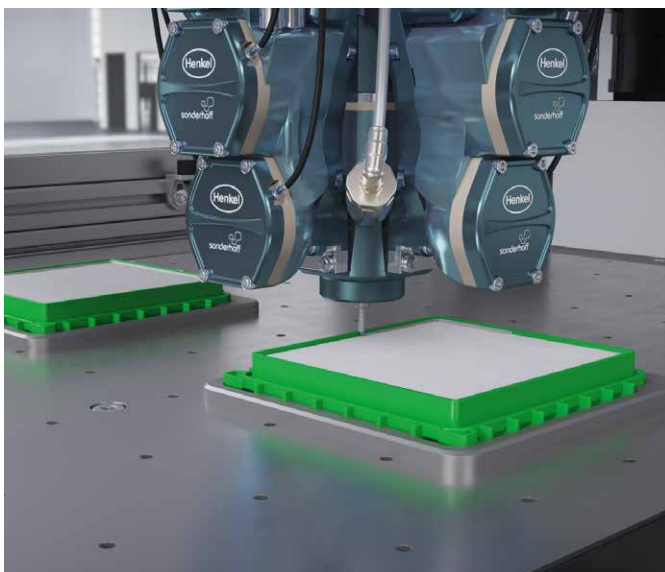

FERMADUR adhesive sealant dosed application with the MK 800 PRO mixing head for bonding the filter pack into the frame

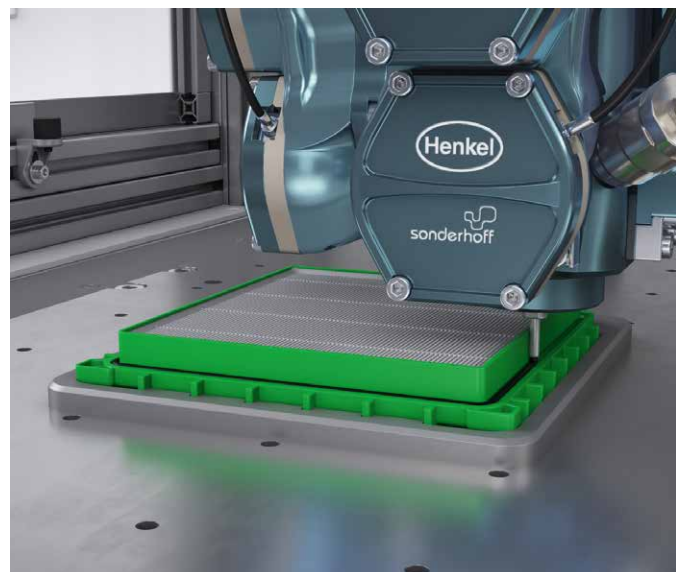

FERMAPOR K31 sealing foam dosed application with the MK 800 PRO mixing head for bonding the filter frame

## SONDERHOFF SMART-L dosing cell with transfer belt

### Continuous parts feeding in a defined sequence

The SONDERHOFF SMART-L dosing cell, equipped with a lifting door at the front, can optionally have the components fed to the working area for the dosed application via a transfer belt that runs through the cell. The circulating transfer belt also enables balancing in terms of components and serves as an initial curing section until the applied sealing foams, adhesive sealants or potting compounds are tack-free.



SMART-L dosing cell with circumferential single track transfer belt



Loading of workpiece carriers and feeding on the conveyor belt to the dosing cell

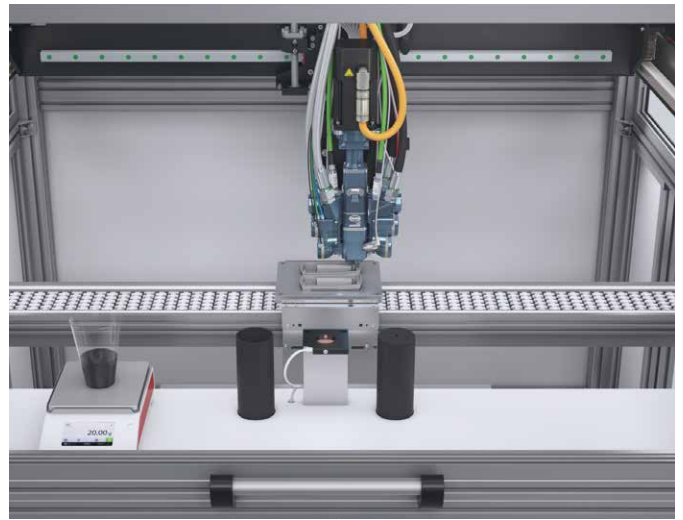

Workpiece carrier stops at the centering device



The MK 800 PRO mixing head is in the filling shot position.

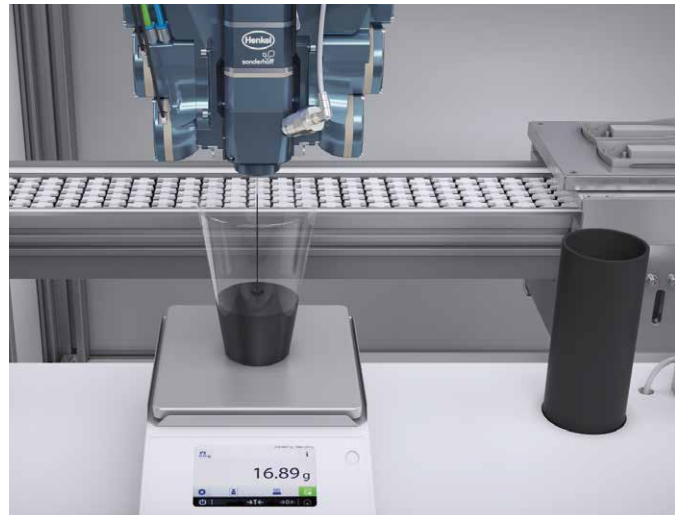

WEIGHT-CONTROL of the output quantity defined for the dosed application



The CNC-guided mixing head precisely positions itself above the component and doses the potting compound.

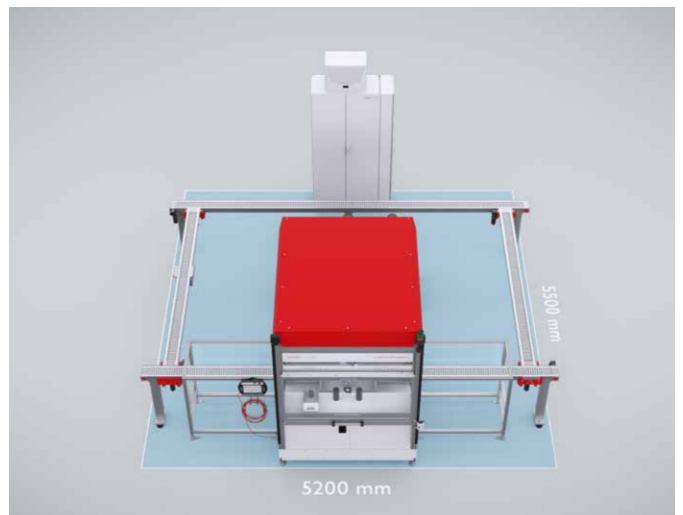

The configuration of the SMART-L dosing cell with circulating transfer belt requires a footprint of approx. 29 sqm.

# SONDERHOFF SMART-L and SMART-M

## SPECIFICATIONS

### CONTROL CONCEPT

- Multi-function SONDERHOFF MP 2 Mobile Panel with integrated 10.1-inch touchscreen
- Intuitive operation with programmable keys, function keys and touch keys
- Modular IPC control installed in the control cabinet with Powerlink
- EMERGENCY STOP switch-off with a tried-and-tested safety concept, realtime-capable bus system
- Control cabinet pluggable
- Preselection for Setup / Stand-by / Manual / Automatic operating mode
- Recipe management
- Operator password protection selectable on 4 levels
- Programmable pot life monitoring and dosing quantity preselection as well as automatic rinsing and material conditioning (air loading, stirring, etc.)
- Automatic and spontaneously available flow rate adjustment through pressure regulation
- Component pressure monitoring, digital component pressure display
- Clock timer with automatic switch-on
- Open peripheral interface
- Central control of additional peripherals/automation possible
- Data backup by means of USB stick, serial interface or LAN
- Data storage for operating system and system programs on CFast memory cards

### DRIVE TECHNOLOGY / DRIVING POWER

- Speed-controlled servo gear motor with speed display and adjustment on the display
- Pumps: 1.01 kW; 1 – 400 rpm
- SONDERHOFF MK 800 / MK 825 BASIC, PLUS or PRO mixing head: 1.01 kW; 1 – 6,000 rpm

### TECHNICAL DATA OF LINEAR ROBOT

- Max. travel speed: 20 m/min
- Max. acceleration: 5 m/s<sup>2</sup>
- Repeat accuracy: ±0.1 mm
- Travel range: SONDERHOFF SMART-L: 1,000 x 800 x 250 mm (x/y/z); SONDERHOFF SMART-M: 500 x 600 x 250 mm (x/y/z)

### PRECISION GEAR PUMPS (OPTIONALLY)

- For FIPFG sealing foam, size: 0.05 / 0.10 / 0.30 / 0.40 / 0.75 / 3.0 / 12.0 ccm/rev.
- For potting/adhesive applications, size: 0.05 / 0.10 / 0.30 / 0.60 / 1.20 / 3.0 / 6.0 / 10.0 ccm/rev.
- Special pumps on request

### PNEUMATIC SYSTEM

- Pneumatic system with filter pressure reducer, maintenance unit with pressure monitoring and valve cluster for controlling the pneumatic consumers

### CONNECTION VALUES

- Electrical system: Design according to EN 60 204-1
- Power supply: 3 x 400 V, 50 Hz or 60 Hz, or in country-specific special voltage
- Rated power: approx. 10 kVA
- Ø consumption: approx. 4 kVA
- Compressed air connection value: approx. 150 l/min at 6 –7 bar
- Water connection value: approx. 13 l/min at at least 4 bar

### DIMENSIONS (WITHOUT CONTROL DESK AND CONTAINER PLATFORM)

- SONDERHOFF SMART-L: 1,700 x 2,400 x 1,985 mm x 950 mm (width / height / depth / height of working area)
- SONDERHOFF SMART-M: 1,200 x 2,400 x 1,700 mm x 950 mm (width / height / depth / height of working area)

- Platform incl. material container (per component): W x H x D 625 x 1,500 x 860 mm, approx. 85 kg
- Control cabinet: W x H x D 1,210 x 2,650 x 510 mm, approx. 350 – 450 kg

#### GENERAL INFORMATION

- Chassis: closed cell design with Makrolon panes
- Container platform: Galvanized grating, with adjustable leveling feet and drip tray, standing separately
- Mixing ratio: from approx. 100 : 1 to approx. 1 : 100, continuously adjustable
- Application rate: from approx. 0.2 to approx. 3.0 g/s (SONDERHOFF MK 825 BASIC, PLUS or PRO), from approx. 3.0 to approx. 100.0 g/s (SONDERHOFF MK 800 BASIC, PLUS or PRO)
- Viscosity processing range: 1 – 2,000,000 mPas, other viscosities on request

## OPTIONS

#### CONTROL

- Operation via SONDERHOFF CONTROL 2 with 21.5-inch touchscreen, either mounted on a rollable support or on a swivel arm
- Display language switching: German, English, French, Spanish, Italian, Chinese
- Other country-specific language adjustments possible
- Strand identification
- Switch cabinet lighting
- Operating hours meter
- Remote maintenance via VPN router
- Voltage adjustment to external voltages

#### QUALITY CONTROL

- SONDERHOFF LBM 3 measuring and control unit for air loading
- Set-up and alarm logging, process data logging
- Further quality control equipment adaptable according to customer requirements

#### MATERIAL PREPARATION

- Material pressure tank with capacitive minimum fill-level sensors, safety pressure valve (TÜV type-tested) and shut-off ball valve, with compressed air fittings and compressed air reducing valves for pre-pressure regulation of the tank pressures
- Material pressure tanks: 24 l or 44 l, single-walled or double-walled, chrome-nickel steel
- Wire mesh filter cartridges and plate gap filters
- Three-phase agitator running at 23 rpm, or alternatively at 96 rpm
- Electric heating for single-walled containers
- Temperature control for double-walled containers
- Automatic air loading
- Manual evacuation
- Preparation for the control of an automatic refilling device
- Material supply through refilling stations for containers from 20 to 1,000 liters

#### HOSE PACKAGE

- Recirculation hose package
- Electric heated hoses with steel-reinforced Teflon high-pressure hose core

#### MIXING HEAD VARIANTS

- MK 800 BASIC, PLUS or PRO with recirculation or stub line and high-pressure water rinsing
- MK 825 BASIC, PLUS or PRO with recirculation or stub line and high-pressure water rinsing

#### GENERAL INFORMATION

- Material supply monitoring for component pumps
- Compressed air dryer
- Workpiece automation with shuttle table
- Workpiece automation optionally as rotary indexing table
- Rinsing and filling shot container
- Removable cell cover made of powder-coated sheet steel
- Spare parts packages
- Transportation, commissioning and training

# TECHNICAL SER- VICE

**Combined Service Package  
for the All-Round Service**  
Page 48







# Combined service package for the all-round service

## Interaction of pro-active inhouse service, experienced on-site service and quick response online service

The productivity of a machine is significantly determined by its reliable availability. This is why we ensure the intelligent minimization of error-related downtimes and maintenance-related production interruptions.

To this end we can offer you various forms of maintenance and servicing for our dosing machines – from on-site maintenance to the preventive maintenance of machines at regular intervals, to the even more effective approach of predictive maintenance using sensor-based data collection, with subsequent analysis and evaluation.

Our service package is a further reliable pillar of our system solutions. It contains:

- a risk analysis
- pro-active inhouse service
- skilled on-site-service
- quick response online service (remote collaboration)
- spare parts supply

With this package, we support you in the reliable planning and execution of your production processes and predictive maintenance.

### **Inhouse service: Proactive service is the best protection against machine downtimes**

The Inhouse Service forms the basis of our after-sales services. Here, all services are provided that can be planned in advance through predictive maintenance and which ensure continuous machine operation. Key elements here are the risk analysis of your dosing machines during ongoing production and our associated consulting service for perspective production planning.

### **Online service: Distance no longer matters**

With the Remote Collaboration offer, we use audio, video and machine data communication via a VPN connection for our services in order to support you directly and quickly in an emergency. This enables us to discuss specific tasks with you and eliminate any operating errors. This service can also be used for online training, which reduces the cost and time required for this.

### **On-site service: We will be happy to come to you!**

We can provide you with on-site support in the form of a wide range of services from our service technicians:

- Commissioning of machines
- Creation of complex dosing programs
- Machine inspection according to cost or with service contract
- Machine repairs
- Machine relocation for production site changes
- On-Site Training

### **Service contract and spare parts supply**

By concluding a service contract, you receive optimum support for your production – from regular checks of the optimum functionality of your dosing system, to a system inspection using original spare parts from our high-bay warehouse, to machine repair and rapid assistance in the event of damage.



Inhouse service



On-site service



Online service



Service contract



spare parts supply



## This is why you should use FIP technology in your production process



### Advantages of the Formed-In-Place technology

- Sealing standard in many industrial sectors
- Highly accurate material application controlled by contour robots
- Processing and full curing at room temperature
- Perfect coordination of the material system and dosing system
- Suitable for 2D and complex 3D part geometries
- More efficient use of materials compared to punched seals
- Cheaper compared to 2-C injection molding, as there are no tooling costs
- High degree of future viability, due to suitability for use in a wide variety of industries & applications



### Advantages of our mixing and dosing machines

- Combination of processes (bonding, foaming, caulking, potting)
- High flexibility of the dosing system
- Simple, intuitive operation
- Automatic material preparation incl. handling
- High dosing and repeat accuracy
- Short machine downtimes and cycle times
- Fine-cell foam structure due to dynamic mixing
- Reproducible foam quality
- Ecological high-pressure water rinsing
- Easy maintenance



### Advantages of our FIPFG foam gaskets

- More cost-effective than compact systems due to lower foam density
- Seamless seal / hardly visible coupling point
- Compensation of component tolerances
- Good resilience
- Multiple compression and release processes possible
- Broad range of properties / wide variety of recipes
- Individually adaptable recipes
- Good form fit to the component contour
- Resistant to moisture, dust, temperature & media
- Flame-retardant according to UL 94
- IP classes up to IP 68 or NEMA 4 to 6 and NEMA 12
- Special PU foam with low VOC emissions
- Very fast reacting PU foam (Fast-Cure)

## Perfectly coordinated solutions for material, machine and contract manufacturing

With its Sonderhoff brand, Henkel has not only acquired many years of experience in the manufacture of tailor-made 2C sealing systems and mixing and dosing machines, but also as a process expert for application-specific material application using the FIPFG (Formed-In-Place-Foam-Gasket) technology.

With the Sonderhoff portfolio, we offer all the advantages of a system provider from a single source and the solutions to meet your technical and commercial challenges.

With the dosing technology that is tailored to our sealing foams, we ensure efficient production processes in accordance with the requirements of fully automated series production.

If you would like to take advantage of all the benefits of the FIPFG technology for your production in a flexible, fast, uncomplicated manner and without having to make your own acquisition investments, we can provide expert sealing for your components at one of our contract manufacturing sites worldwide. There, the spectrum ranges from the sampling of prototypes and small batch series to production scale manufacturing.

The choice is yours! You can either decide in favor of our all-inclusive package, consisting of material, machine and contract manufacturing, supported by application advice, sampling and training... or you can choose the individual solutions that suit you best. We combine our products and services from a single source in such a way that you receive the optimum solution for your requirements profile.

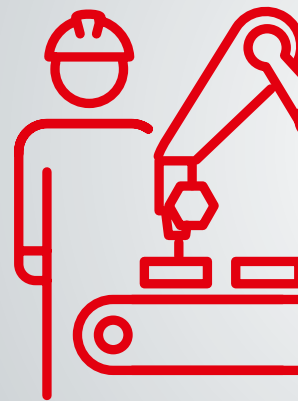

**MANUFACT**

# *Flexibility & Precision*

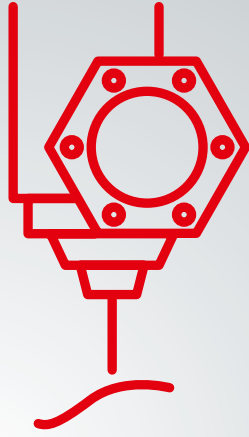

**EQUIPMENT**

# Automation Solutions

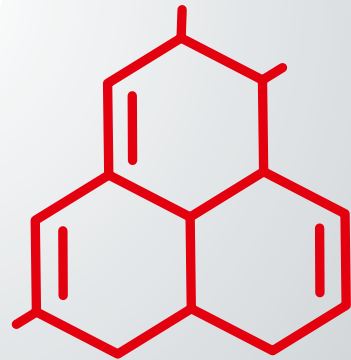

**MATERIALS**



**MANUFACTURING**

# Customer-specific solutions – worldwide and for many industries

The Henkel specialists for the Sonderhoff portfolio  
are available globally

**KOLO, POLAND**  
External Subcontracting Location

**LONDON, GB**  
External Subcontracting Location

**DÜSSELDORF, GERMANY**  
Center of Expertise

**ELGIN, ILLINOIS, USA**  
Regional Hub

**RICHMOND (KANSAS CITY), USA**  
Regional Hub

**DORNBIRN, AUSTRIA**  
Center of Expertise

**BARCELONA, SPAIN**  
External Subcontracting Location

**OGGIONO, ITALY**  
Regional Hub

**INCHEON, KOREA**  
External Subcontracting Location

**SHANGHAI, CHINA**  
Regional Hub

**PUNE, INDIA**  
Regional Hub

**PUNE, INDIA**  
External Subcontracting Location

**SÃO PAULO, BRAZIL**  
External Subcontracting Location

*Global presence*





Every year, more than 300 million seals are manufactured in more than 50 countries using products from Henkel's Sonderhoff portfolio. At our Centers of Expertise and Regional Hubs, our specialists offer application engineering advice, e.g. on the selection of a suitable material system and the sampling of your components, as well as project management for dosing systems and automation. You will receive training from us on how to use the FIPFG technology and we will support you with the selection of spare parts and a regular service offering. Furthermore, we will be pleased to take over parts of your production for you – from small to large series – at our subcontracting locations.

Sales staff at all other Henkel locations worldwide will also be happy to answer any questions and provide you with further information on our sealing, bonding and potting solutions. We look forward to hearing from you.



**Henkel AG & Co. KGaA**

Henkelstraße 67  
40589 Düsseldorf  
Germany  
Tel.: +49 211 797-0  
Fax: +49 211 798 4008

[www.henkel.com](http://www.henkel.com)  
[www.sonderhoff.com](http://www.sonderhoff.com)

Get in contact with us



The description of the possible fields of use of our products as well as the technical data and values only have a general character and do not mean that a certain product can be used under all conditions in the respective field of use. In this respect, the stated field of use is not a binding specification or usage provision. Due to the great number of environment variables and their influences (e.g. temperature, test specimens, size, interaction with substrates, influence of machines, or the like) you as our customer must check whether the product is suitable for your specific field of use. We will be pleased to assist and advise you in this respect. Except as otherwise noted, all marks used above are trademarks and/or registered trademarks of Henkel and its affiliates in the U.S., Germany and elsewhere.

© 2022 Henkel AG & Co. KGaA. All rights reserved.