

# SONDERHOFF 3E PUR

Dosing cell with optional shuttle table for the processing and dosing of 2K polyurethane systems



# The new SONDERHOFF 3E PUR with DM 50x technology

Dosing cell with the highest process stability for automated sealing, bonding and potting of 2K PUR systems

The SONDERHOFF 3E PUR compact dosing cell is a low-pressure mixing and dosing machine, which handles liquid, moderately viscous and highly viscous 2-component polyurethane material system for exact processing, dynamic homogeneous mixing, and precise dosing. The 2K material system used is applied to the components in a fully automatic process using FIPFG technology (formed-in-place foam gasket).

When developing the new 3E dosing cell generation for seal foaming, bonding and potting of industrial components, we have focused on the key features of a modern dosing machine and designed it for the most frequently used application characteristics.

**In addition to the 3E PUR, we offer two other machine types. These are the 3E SIL for 2K silicone systems and the 3E FLEX as an expandable dosing cell for optional configurations.**

All three machine types of the 3E are equipped with DM 50x technology and different precision mixing heads from the MK 825 series, which feature impressive innovative improvements. They ensure maximum process stability for the fully automatic dosing of the 2K material systems used. An attractive entry price enables very short payback periods, and the high degree of standardization also shortens delivery times.

## **Optimized process evaluation and control**

Thanks to the MK 825 mixing head technology used in the new SONDERHOFF 3E PUR dosing cell, the machine operator has access to a comprehensive database. It enables preventive maintenance of wearing parts.

In order to ensure continuously high machine availability, various technical service concepts are available. The fundamental idea here is preventive and scheduled maintenance.









**1**

**Mixing head  
MK 825 BASIC**

MK 825 BASIC precision mixing head with high-pressure water rinsing

**PAGE 10**



**2**

**Linear robot**

The 3-axis linear robot ensures repeatable guidance of the mixing head over the component being processed.

**PAGE 8**



**3**

**Control cabinet**

The control electronics, servo and safety engineering, and the industrial PC are installed in an air-conditioned switch cabinet.

**PAGE 14**



**4**

**Operation & programming via the Sonderhoff user interface**

The multi-functional MP 2 Mobile Panel with touchscreen (10.1" WXGA TFT) for programming and operating the dosing machine.

**PAGE 16**

**SONDERHOFF 3E PUR dosing cell**





5

### Lifting door

Lifting door with safety monitoring for manual closing and opening of the mixing head travel area in the dosing cell ensures the CE conformity of the dosing system.

**PAGE 9**



6

### Dosing components and material containers

At the front left side are e.g. the precision gear pump, the high-pressure water unit for mixing head rinsing, and the material pressure tank for the A and B components.

**PAGE 12**



7

### Filling shot and rinse water tanks

At the front right side is the opening for removing the filling shot and rinse water tanks.

**PAGE 15**



### Shuttle / sliding table (optional)

Two alternately operated manual mounting plates

**PAGE 18**

## for 2K polyurethane systems: overview



# The compact class for standard applications

## Place, plug & work!

With the dosing cell SONDERHOFF 3E PUR (Economic, Efficient & Ecological), you can get to work right away:

### Place, plug & work!

As soon as power, water and compressed air are connected and the two material components of the chosen 2K PUR system are filled into and prepared in the separate material pressure tanks, production can begin. With the 3E PUR, even small and medium quantities can be produced very economically.

The dosing machine is equipped with a manually operated lifting door. Accordingly, the machine is CE-compliant, so that no additional safety fences or light barriers are required. This boosts efficiency, saving space and costs.





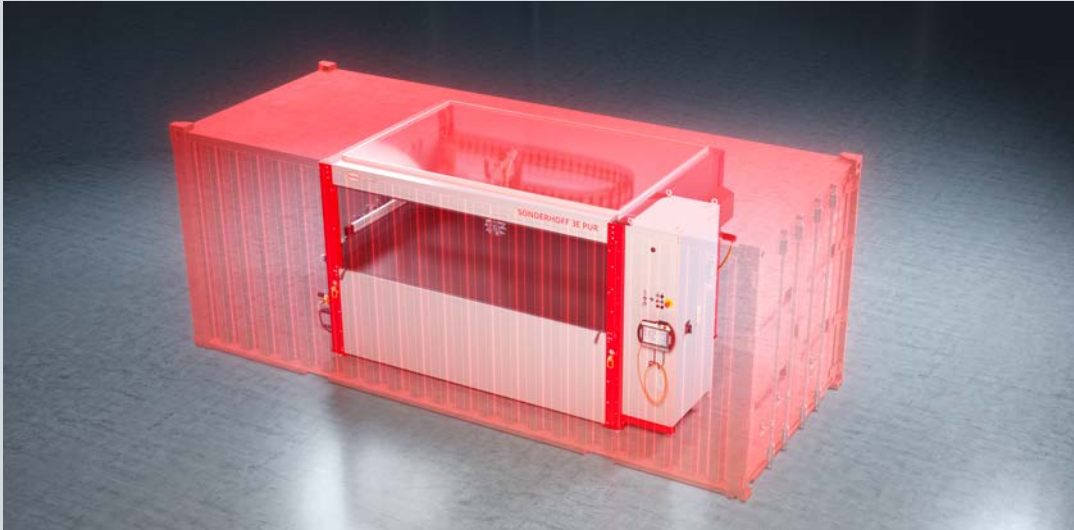

The SONDERHOFF 3E PUR dosing cell is designed in such a way that it can be delivered in a container, fully assembled as a single unit, and only needs to be set up and connected at its installation location.



The dosing cell is removed from the transport container, set up and connected: place, plug & work. All features are arranged on a single chassis so that the dosing cell can be changed over very easily in production.



The dosing cell can be used flexibly as a production island, and with an installation footprint of approx. 9 square meters requires very little space.

## SONDERHOFF 3E PUR

Mixing and dosing machine in cellular design  
for processing and dosing 2K PUR systems



The SONDERHOFF 3E PUR dosing cell comprises the MK 825 BASIC precision mixing head for 2-component products with high-pressure water rinsing for mixing chamber cleaning. In the mixing head the material components are mixed dynamically, and the material system to be applied to the part is dosed in precise quantities. The MK 825 BASIC enables dosing from 0,2 to 3,0 g/s with continuously adjustable, asymmetrical mixing ratios from 10 : 1 to 1 : 2 and a dosing accuracy of  $\pm 1\%$ .

The MK 825 BASIC is precisely guided within the travel range of 2,500 x 1,250 x 250 mm (x/y/z) by a 3-axis linear robot integrated into the cell. The linear robot features a toothed-belt drive and excellent stiffness for a repeatable guidance of the mixing head over the part to be processed.



Half-open lifting door shows MK 825 BASIC precision mixing head and energy chain



Standard equipment: MK 825 BASIC precision mixing head for 2 components, with high-pressure water rinsing



## Operating the dosing machine 3E PUR

The machine operator places one or more parts on the prepared workpiece holder within the working area of the dosing cell. He then closes the lifting door with a hand lever at the front of the machine. The fully automatic application of material to the part can start. For this purpose, the CNC-controlled MK 825 BASIC precision mixing head moves over the part contour.

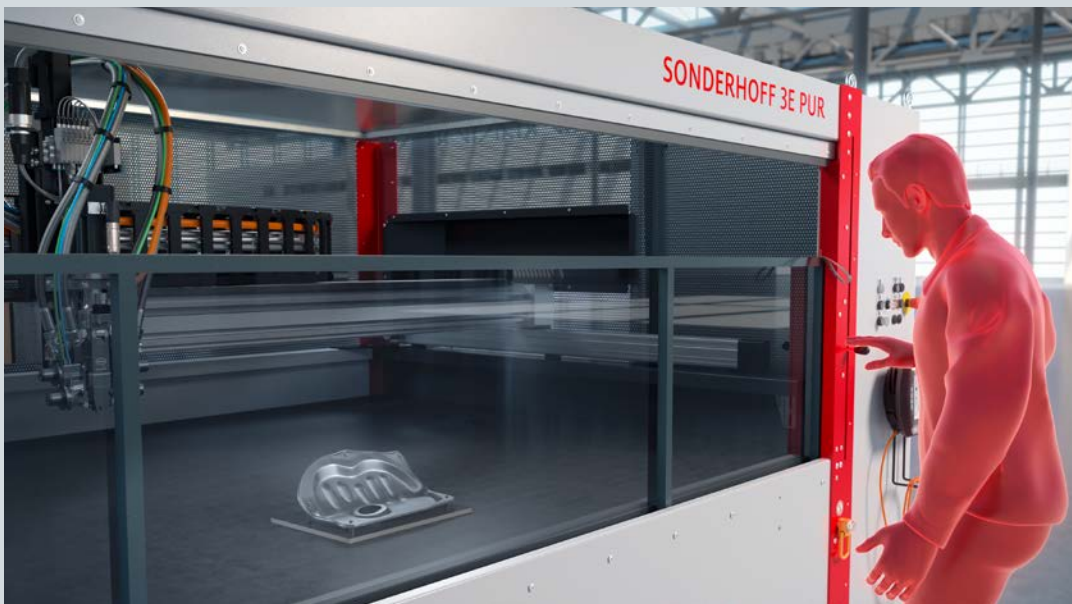

To remove one or more parts after the dispensing process, the machine operator opens the lifting door using either the hand strap mounted there or the lever.

# The MK 825 BASIC

2-component mixing head with high-pressure water rinsing and dynamic mixing

## DESCRIPTION OF THE MK 825 BASIC

- 2-component mixing head with high-pressure water rinsing and dynamic mixing for liquid to highly viscous polymeric reaction materials for seal foaming, bonding and potting
- High-pressure water rinsing for ecological cleaning of the mixing system using high-pressure needle valves for rinsing water injection
- Alternatively, rinsing with non-reactive material components
- Hydromechanically regulated precision recirculation valves for precise dosing
- Weight-reduced construction of a modular design, blue-gray anodized
- Robust and maintenance-free design made of high-strength aluminum alloy and chrome steel
- Direct stack injection of the components
- Electronically adjustable mixer speed
- Special mixer design enables gentle material mixing
- Blowing air needle valve for drying the mixing system
- Low-drip, low-maintenance nozzle shut-off system STOP-DROP DVS 3
- Simple stroke adjustment by means of an adjusting wheel
- Material pressure measurement on the dosing valve





TECHNICAL DATA*	MK 825 BASIC
<b>Dimensions (H x W x D) 2K mixing head</b>	248 x 237 x 151 mm
<b>Operating pressure</b>	up to approx. 20 bar
<b>Discharge rate</b>	0,2 to 3,0 g/s
<b>Dosing accuracy</b>	±1 %
<b>Mixing head weight</b>	approx. 5.5 kg
<b>Mixing ratio</b>	continuously adjustable from 10:1 to 1:2
<b>Selectable mixer speed</b>	continuously adjustable from 1 – 4,500 rpm
<b>Viscosity processing range</b>	Material component A: 1,000 – 100,000 mPas (*) Material component B: 200 – 1,000 mPas (*)

\* Depending on the mixing ratios, material viscosities and the selection of pumps, hoses and mixing elements.

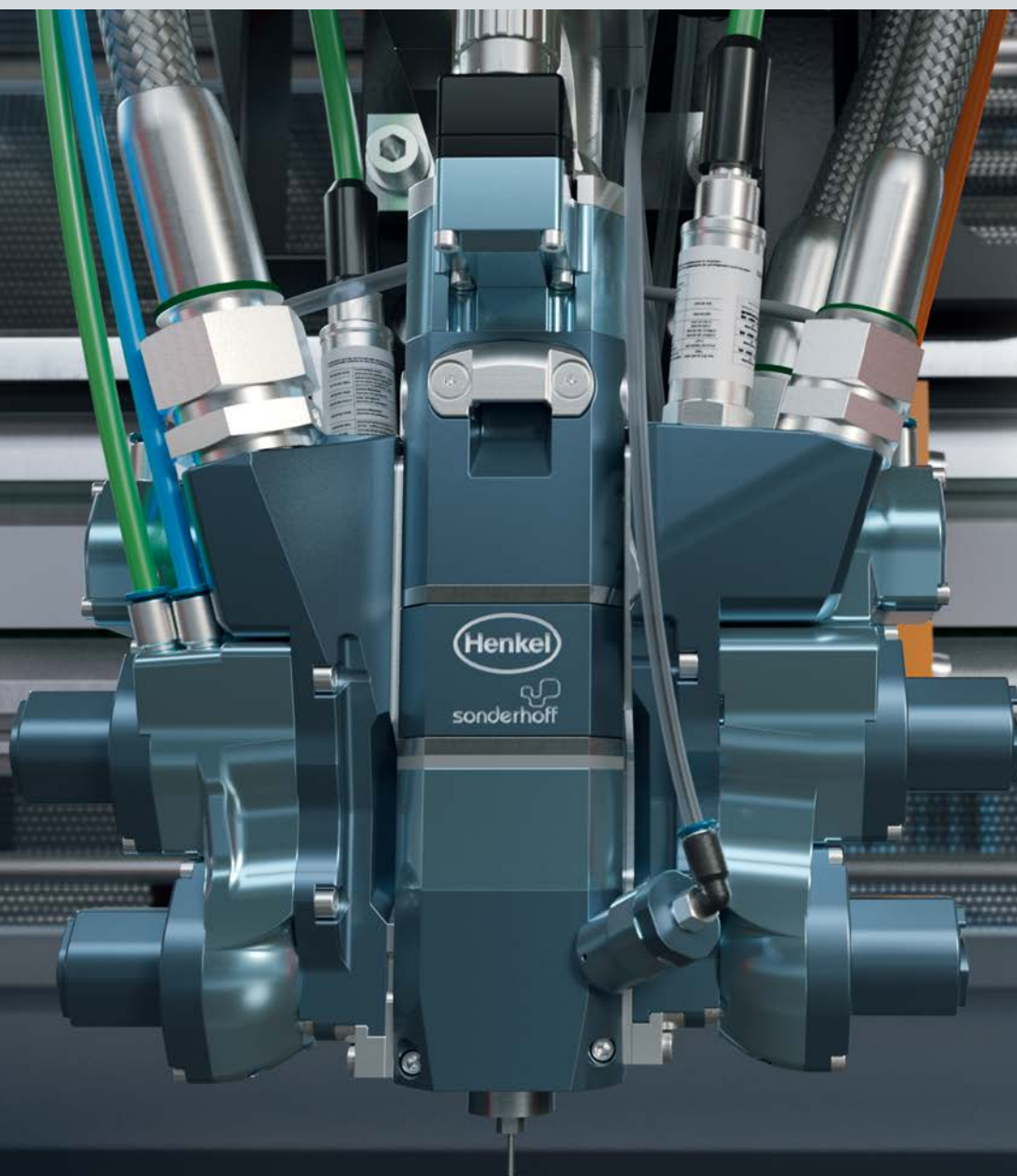

# Dosing machine components and material containers

## Top precision and user-friendly maintenance

In the SONDERHOFF 3E PUR dosing cell, the dosing machine components are mounted on the side of the cell. This is where e.g. the precision gear pumps, compressed air connection and dryer, and the maintenance unit and high-pressure water unit for mixing head rinsing are located. The double-walled material pressure tanks in the optimized sizes for the asymmetrical mixing ratios of the A and B components of the 2K polyurethane systems are also installed here. The material pressure tanks are equipped with various sensors, indicating whether the pressure tank is empty or needs to be refilled. For the material pressure tanks, an extension with a refilling station for automating the material supply is possible on request. For that case there is an overfilling protection mechanism on the pressure tanks.

### MATERIAL PREPARATION FOR THE 3E PUR

- Material pressure tank with fill-level sensors, safety pressure valve (TÜV type-tested), overfilling protection and shut-off ball valve, with compressed air fittings and compressed air reducing valves for pre-pressure regulation of the tank pressures
- 44 l material pressure tank, double-walled, chrome-nickel steel for material component A
- 24 l material pressure tank, double-walled, chrome-nickel steel for material component B
- Wire mesh filter cartridges and plate gap filters
- Three-phase agitator running at 99 rpm for tank A
- Automatic air loading
- Optional: material supply through refilling stations for containers from 20 to 1,000 liters
- Precision gear pumps: delivery rate 0.75 ccm/rev (material component A) and 0.3 ccm/rev (material component B)
- Hose package: material component A: fabric-reinforced polyamide high-pressure hose, material component B: steel-reinforced Teflon high-pressure hose, recirculation hose package

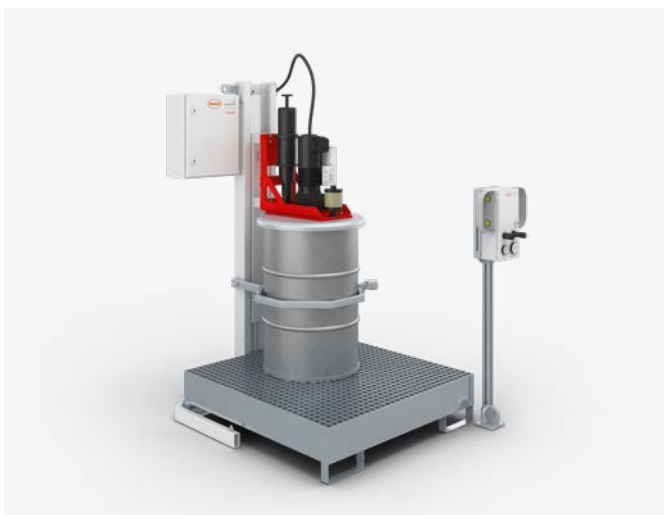

**ELEVATOR:** Automatic drum refilling station with lifting device and controlled agitator for liquid and thixotropic products (e.g. polyols)



**SUPPLY TAP:** Automatic drum refilling station for low-viscosity products (e.g. isocyanates)



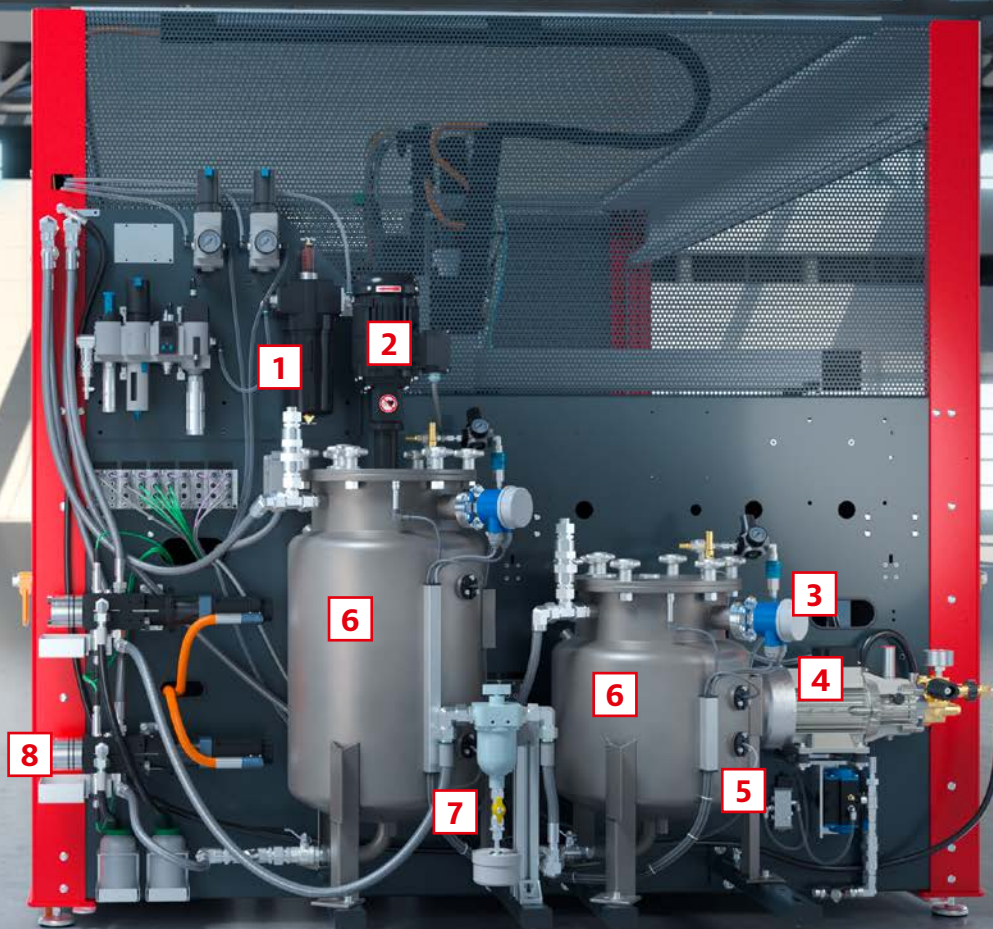

Compressed air connection, dryer and maintenance unit



Agitator for homogenization of the material component A



Overfilling protection for the use of an optional refilling station



High-pressure water unit for effective and ecological mixing head rinsing



Capacitive sensors for filling level regulation



Material pressure tank with optimized dimensions for asymmetrical mixing ratios



Plate gap filter for the material component B



Precision gear pumps with flow rate 0.75 ccm/rev (material component A) and 0.3 ccm/rev (material component B)

# Control cabinet

## The expandable future-proof control center

The switch cabinet is the expandable future-proof control center of the SONDERHOFF 3E PUR dosing cell with DM 50x technology. It includes the electrical distribution as well as the control and safety technology for the dosing machine and the CNC control of the 3-axis linear robot installed in the cell.

With the programmable safety logic, adjustments to the safety function are now simple and quick to implement. The safety functions of the 3-axis linear robot's servo axes are fully integrated into the safety logic and can therefore also respond very quickly to safety events. The digital EnDat encoders of the servo motors ensure very precise path behavior of the servo axes when moving the mixing head. The power supply of the servo controllers is provided by a central module, which also handles the communication of the control system.

### CONTROL CONCEPT

- Servo technology with integrated safety logic
- Safe Limited Speed / Safety Modules
- Modular B & R branded "IPC control system" with Powerlink
- VPN router for remote maintenance (remote collaboration)
- Cooling device for switch cabinet temperature control
- Clock timer with automatic switch-on
- EMERGENCY STOP switch-off with a tried-and-tested safety concept, realtime-capable bus system
- Switch cabinet mounted on the common dosing cell chassis
- Data backup by means of USB stick or via LAN
- Data storage for operating system and system programs
- Safety deactivation on the lifting door



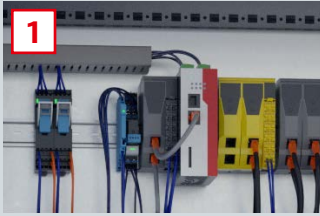

VPN router for remote maintenance (remote collaboration)

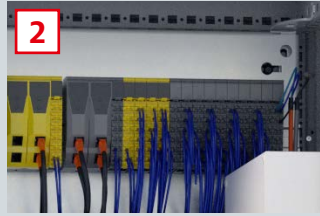

Safe Limited Speed / Safety Modules



Modular B & R "IPC control system" with Powerlink



Cooling device for switch cabinet temperature control



Servo technology with integrated safety logic



Right side of the SONDERHOFF 3E PUR dosing cell shows the switch cabinet attached to the cell chassis for controlling the dosing machine, to the left of which you see the holder for the MP 2 mobile panel, and to the right the opening for removing the filling shot and rinse water containers

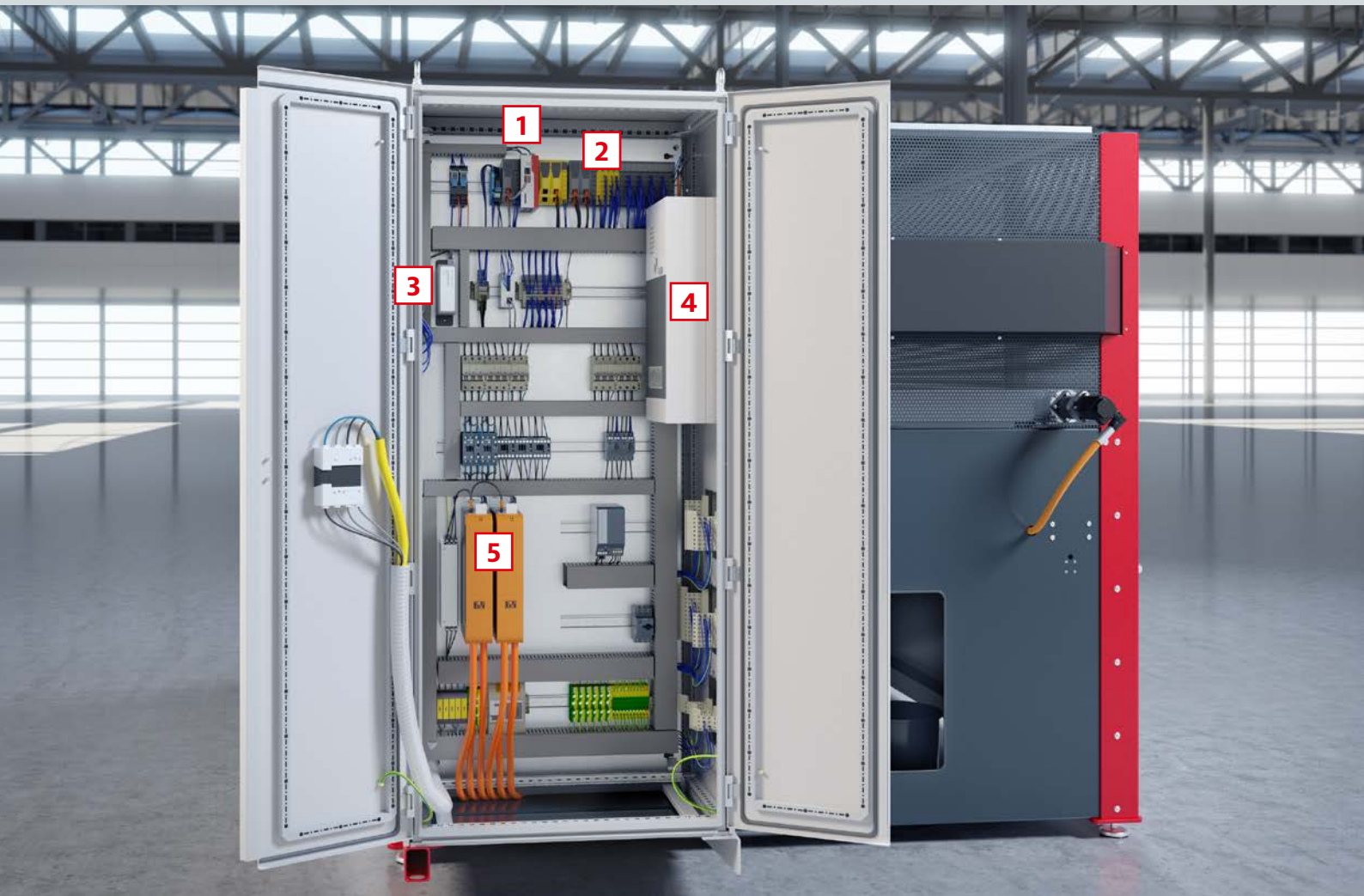

# Multi-functional MP 2 mobile panel

## Convenient operation and working



MP 2 mobile panel and above it the operating mode control panel, e.g. key switch for operating mode preselection with selection for the operating modes of Setup / Stand-by / Manual / Automatic, warning lights and EMERGENCY STOP, part of the tried-and-tested SONDERHOFF SAFETY concept.

The SONDERHOFF 3E PUR dosing cell is designed to enable the operator to perform a wide variety of tasks easily and safely. The system is operated via the easy-to-use, multi-functional Sonderhoff MP 2 mobile panel with integrated 10.1" touchscreen. This makes the contour programming of components significantly simpler.

The MP 2 mobile panel continuously provides information on the performance status of the system and the process data recorded. This ensures traceability of the preceding production process at all times. In addition, the sensor system installed in the dosing machine continuously supplies measurement data on the factors influencing the production process, which can be prognostically evaluated and proactively readjusted.

### EQUIPMENT FEATURES

- Multi-functional MP 2 mobile panel with integrated touchscreen (10,1" WXGA TFT)
- Intuitive operation with programmable keys, function keys and touch keys
- Display language options for DE, EN, ESP, IT, F & CHIN, further languages upon request
- Modular IPC control system in the switch cabinet with Powerlink
- Selection for Setup / Stand-by / Manual / Automatic operating mode
- Recipe management
- Operator password protection selectable on 4 levels
- Programmable pot life monitoring and dosing quantity preselection, as well as automatic rinsing and material conditioning (air loading, stirring, etc.)
- Automatic and spontaneously available flow rate adjustment through pressure regulation
- Preparation of automatic refilling
- Component pressure monitoring, digital component pressure display

# Visualization of the user interfaces

## Intuitive system operation and simple evaluation of machine parameters

The user interface of the MP 2 mobile panel provides continuous information on the performance status of the dosing cell and the process status of the processing according to the predefined dosing program. Due to the high level of detail of the display, the machine operator can always take corrective action and adjust the process parameters of the system if necessary. The use of universally comprehensible symbols on the operating keys simplifies operation. Clear menu layouts, the use of colored graphics, and the clear structuring of different functions in the operating menu enable intuitive operation and programming of the dosing system.

### Overview of the menu structure:

**1** **First column:** Reactivity of the material (pot life in seconds) for active material components, plus detailed information on the mixing chamber and agitator

**2** **Columns 2-3:** Overview of the two material components, display of the filling level in the pressure tank, line pressure upstream of the pump, speed of pump, line pressure downstream of the pump, component pressure at the valve, recirculation control value in %, recirculation valve offset in mm, recirculation status, dosing control value in %, dosing valve offset in mm, current component dosing rate (g/s)

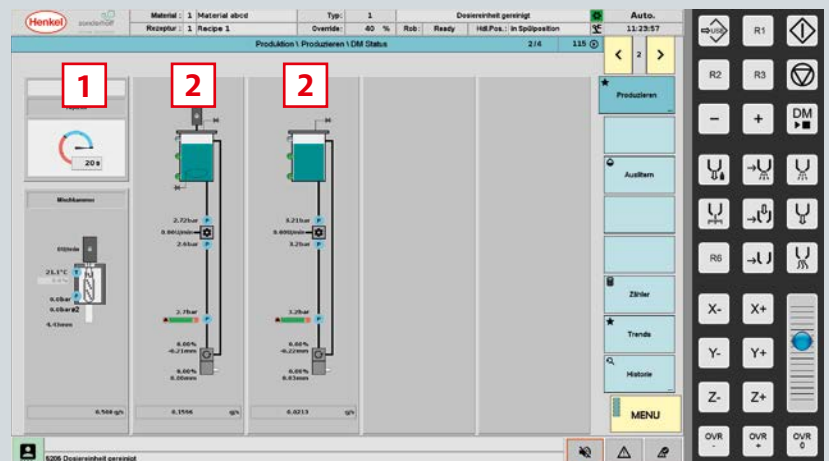

Shows the two material components, the tank level, the pump speed, the line pressure downstream of the pump, the mixing head temperature, the dispensing time (seconds), the discharge line (g/s) and the reactivity of the material (pot life in seconds)

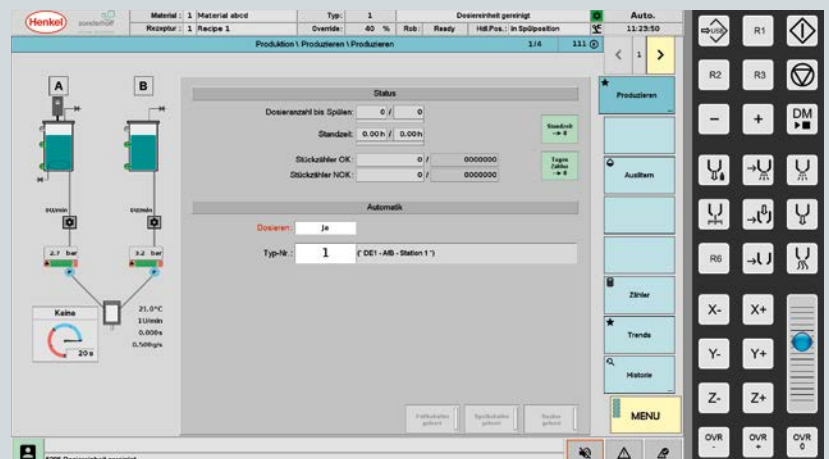



## SONDERHOFF 3E PUR with optional shuttle table

Supply and removal of parts via alternating shuttle mode



The SONDERHOFF 3E PUR dosing cell offers an attachable sliding table with manually shifting mounting plates as an alternative option for placement and processing of industrial parts for sealing, bonding, or potting. With this solution, a machine operator loads the two mounting plates with the parts in an alternating sequence. The parts are positioned in workpiece fixtures, which are fastened on the mounting plates made of coated multiplex.

The machine operator slides the mounting plates into the working area of the dosing cell and closes the lifting door. He then starts the dosing process.

## Alternating shuttle mode

The machine operator positions the parts on the prepared workpiece fixtures fastened on the mounting plates, while in the dosing cell, with the lifting door closed, the CNC-controlled mixing head applies sealing material to the parts positioned on the other sliding table.



After the dispensing application, the machine operator opens the lifting door and pulls the sliding table with the finished parts out of the working area for removal.

## SONDERHOFF 3E PUR with optional shuttle table

Sliding table with connected mounting plates for oversized components



For material application on oversized components, the two mounting plates can be connected to form a single large sliding table.

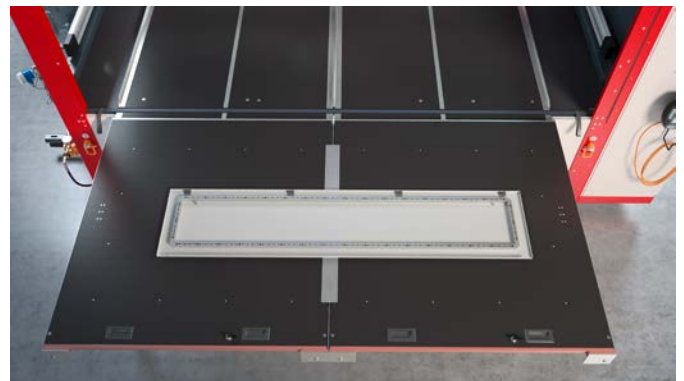

The two mounting plates are connected by couplers to form one large sliding table.



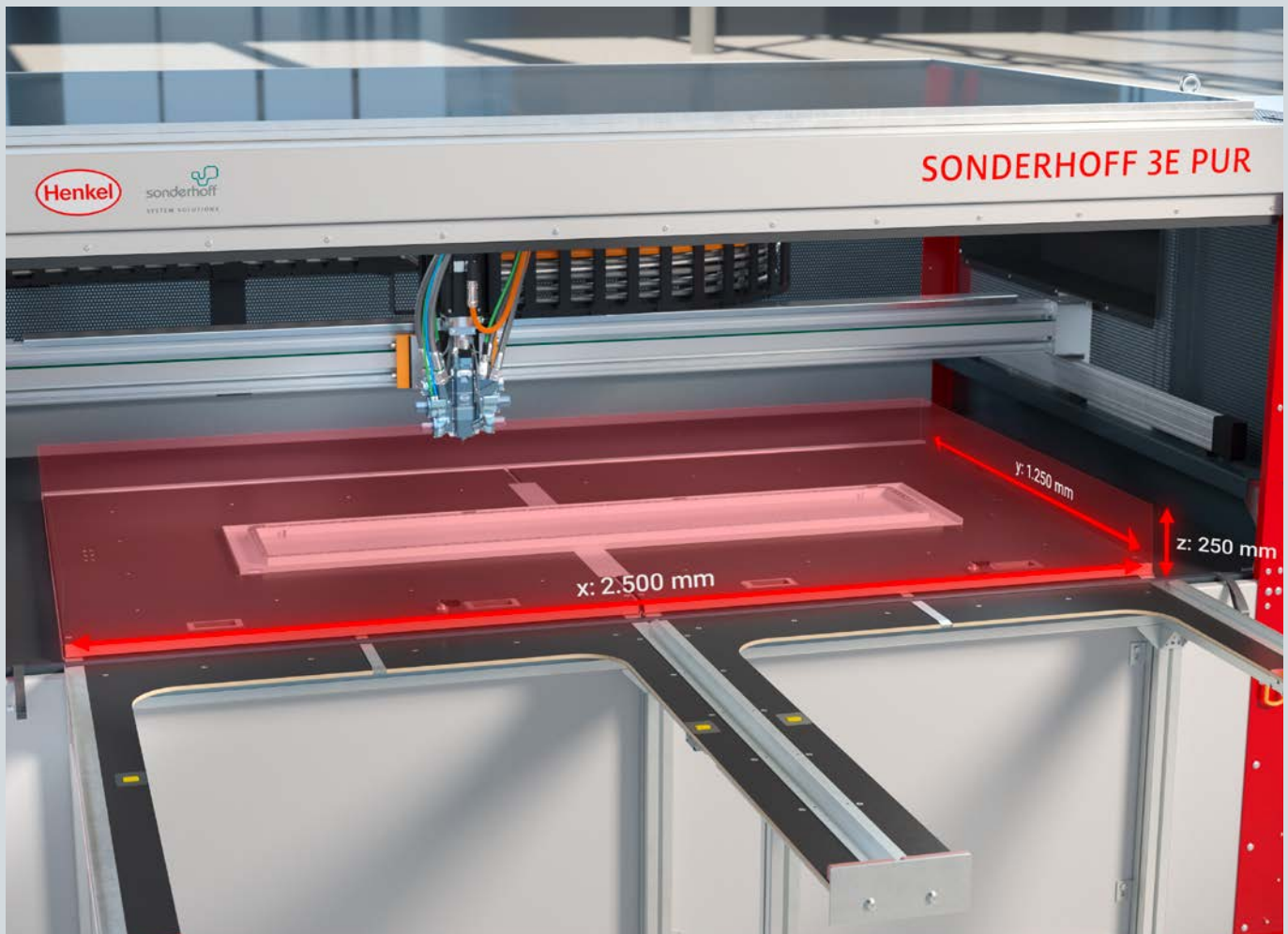

In order to be able to produce oversized components with a maximum dimension of 2,500 x 1,250 x 250 mm (x/y/z), the two sliding table plates are joined together to form one large mounting plate.

### LINEAR ROBOT

<b>Max. travel speed</b>	15 m/min
<b>Max. acceleration</b>	2 m/s <sup>2</sup>
<b>Repeat accuracy</b>	+/- 1 mm
<b>Travel range x/y/z</b>	2,500 x 1,250 x 250 mm

# Automatic refilling stations

## Accurate refilling for a continuous supply of material

The 3E PUR dosing cell can optionally be equipped with a refilling station for automatic material supply. This ensures material-specific preparation, homogeneous consistency and a continuous supply of materials to the material pressure tanks of the mixing and dosing system – without exposure to or contamination of the products to be filled. The BIG ELEVATOR and ELEVATOR refilling stations have an automatic lifting device for improved ease of operation and greater operational and system safety. Production interruptions are therefore a thing of the past.

The stations are controlled via the mixing and dosing system. Capacitive sensors monitor the filling level in the material pressure tanks. A choice of unregulated and regulated agitators with adjustable speed ranges and a programmable timer are available to ensure optimal homogenization of the reaction materials. All refilling stations can be equipped with different stirring elements, depending on the material. Existing production plants can be retrofitted.

### EQUIPMENT FEATURES

- Column with drum lid lift, or alternatively with pump holder (ELEVATOR models)
- The drum lid lifting device is moved pneumatically (ELEVATOR models)
- Optional material conditioning by means of an electric geared agitator with agitator shaft and agitator blade
- Agitator programming with clock timer built into the switch cabinet of the refilling station
- Pneumatic piston pumps or diaphragm pumps, adaptable
- Hose package for connection to the mixing and dosing system
- Drip tray with grating (option)
- Pump and hose set for larger application capacities (optional)

## SPECIFICATIONS

<b>Paint coating</b>	2K textured paint RAL 7035 (light gray) / RAL 3020 (red)	
<b>Piston pump ratio</b>	from 5 : 1 to 10 : 1 / from 10 : 1 to 55 : 1	
<b>Agitator speed</b>	With the unregulated version:	23 rpm at 0.18 kW
	With the regulated version:	20 – 150 rpm at 1.5 kW; alternatively: 30 – 300 rpm at 3.0 kW

## VARIANTS

<b>BIG ELEVATOR</b>	Automatic container refilling station with agitator (0.18 kW), unregulated, without pump; Automatic container refilling station with agitator (1.5 kW or 3 kW), regulated, without pump
<b>ELEVATOR</b>	Automatic drum refilling station with agitator (0.18 kW), unregulated, with piston pump; Automatic drum refilling station with agitator (1.5 or 3 kW), regulated, with piston pump
<b>SUPPLY TAP</b>	Automatic drum refilling station with piston or diaphragm pump



### BIG ELEVATOR

Automatic container refilling station with lifting device and optional regulated or unregulated agitator for liquid and thixotropic products (e.g. polyols)



### ELEVATOR

Automatic barrel refilling station with lifting device and optional regulated or unregulated agitator for liquid and thixotropic products (e.g. polyols)



### SUPPLY TAP

Automatic drum refilling station for low-viscosity products (e.g. isocyanates)



# SONDERHOFF 3E: Economic – Efficient – Ecological

## SPECIFICATIONS

### CONTROL CONCEPT

- Multi-functional MP 2 mobile panel with integrated touchscreen (10,1" WXGA TFT)
- Intuitive operation with programmable keys, function keys and touch keys
- Display language switching for German, English, French, Spanish, Italian, Chinese. Further languages on request.
- Modular B & R branded "IPC control system" with Powerlink in the switch cabinet
- EMERGENCY STOP switch-off with a tried-and-tested safety concept, realtime-capable bus system
- Safety deactivation on the lifting door
- Switch cabinet mounted on the joint dosing cell chassis, with air-conditioning unit for temperature control of the switch cabinet
- Selection for Setup / Stand-by / Manual / Automatic operating mode
- Strand identification
- VPN router, data connection for remote diagnostics and maintenance
- Recipe management
- Operator password protection selectable on 4 levels
- Programmable pot life monitoring and dosing quantity preselection, as well as automatic rinsing and material conditioning (air loading, stirring, etc.)
- Automatic and spontaneously available flow rate adjustment through pressure regulation
- Preparation of automatic refilling
- Component pressure monitoring, digital component pressure display
- Clock timer with automatic switch-on
- Data backup by means of USB stick or via LAN
- Data storage for operating system and system programs

### MATERIAL PROCESSING

- Mixing ratio: from 10 : 1 to 1 : 2, continuously adjustable
  - Application rate: from 0,2 to 3,0 g/s (\*)
  - Selectable mixer speed: continuously adjustable from 1 – 4,500 rpm
  - Pressure monitoring for material supply of the pump
  - Viscosity processing range: component A: 1,000 – 100,000 mPas (\*); component B: 200 – 1,000 mPas (\*)
- (\*) depending on the viscosity and mixing ratio / other application rates and viscosities on request

### PRECISION GEAR PUMPS

- Component A: 0.75 ccm/rev.
- Component B: 0.3 ccm/rev.

### HOSE PACKAGE

- Component A: Fabric-reinforced polyamide high-pressure hose
- Component B: Steel reinforced Teflon high-pressure hose
- Recirculation hose package

### MIXING HEAD

- SONDERHOFF MK 825 BASIC with recirculation and high-pressure water or component rinsing

### MATERIAL PREPARATION

- Material pressure tank with fill-level sensors, safety pressure valve (TÜV type-tested), overfilling protection and shut-off ball valve, with compressed air fittings and compressed air reducing valves for pre-pressure regulation of the tank pressures
- 44 l material pressure tank, double-walled, chrome-nickel steel for component A
- 24 l material pressure tank, double-walled, chrome-nickel steel for component B
- Wire mesh filter cartridges and plate gap filters
- Three-phase current agitator running at 99 rpm for tank A
- Automatic air loading
- Material supply through refilling stations for containers from 20 to 1,000 liters

### PNEUMATICS (OPTIONAL)

- Pneumatic system with filter pressure reducer, maintenance unit with pressure monitoring and valve cluster for controlling the pneumatic consumers

### LINEAR ROBOT

- Max. travel speed 15 m/min
- Max. acceleration 2 m/s<sup>2</sup>
- Repeat accuracy: ± 1 mm
- Travel range x/y/z: 2,500 x 1,250 x 250 mm

### DRIVE TECHNOLOGY

- Pump drive power: 0.6 kW
- Mixing head drive power: 0.6 kW
- Pump drive speeds: 1 - 400 rpm
- Mixing head drive speeds: 1 - 4,500 rpm
- Speed-controlled servo gear motor with speed display and adjustment on the display

### CONNECTION VALUES

- Electrical system: Design according to EN 60 204-1
- Power supply: 3 x 400 V, 50 Hz (voltage adjustment, 60 Hz version available at extra charge)
- Rated power: approx. 10 kVA
- Ø consumption: approx. 4 kVA
- Compressed air connection value: approx. 150 l/min at 6 -7 bar
- Water connection value: approx. 13 l/min at at least 4 bar

### GENERAL

- Dimensions W/H/D approx. 4,217 x 2,065 x 2,130 mm
- Work surface made of coated multiplex board
- Chassis in a compact design, powder-coated
- Weight of the 3E PUR dosing system approx. 1,500 kg
- Compressed air dryer
- Rinsing and filling shot container
- Spare parts packages

## Measurements of the Dosing Cell 3E PUR

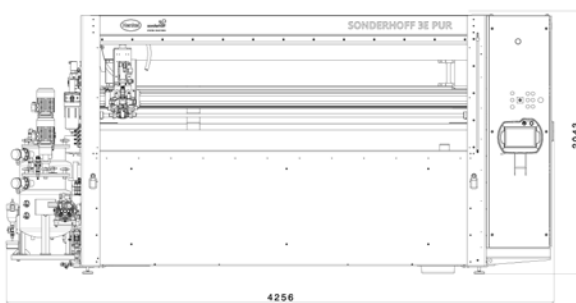

Front view

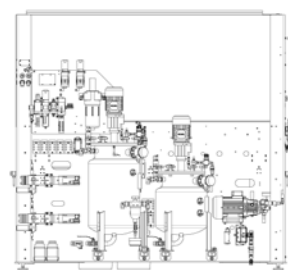

Side view



Top view

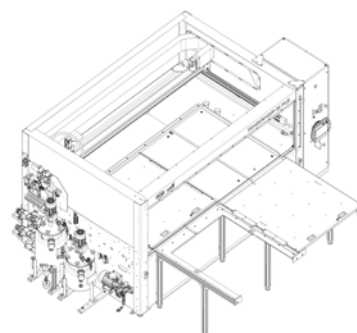

# Combined service package for the all-round service

## Interaction of pro-active inhouse service, experienced on-site service and quick response online service

The productivity of a machine is significantly determined by its reliable availability. This is why we ensure the intelligent minimization of error-related downtimes and maintenance-related production interruptions.

To this end we can offer you various forms of maintenance and servicing for our dosing machines – from on-site maintenance to the preventive maintenance of machines at regular intervals, to the even more effective approach of predictive maintenance using sensor-based data collection, with subsequent analysis and evaluation.

Our service package is a further reliable pillar of our system solutions. It contains:

- a risk analysis
- pro-active inhouse service
- skilled on-site-service
- quick response online service (remote collaboration)
- spare parts supply

With this package, we support you in the reliable planning and execution of your production processes and predictive maintenance.

### **Inhouse service: Proactive service is the best protection against machine downtimes**

The Inhouse Service forms the basis of our after-sales services. Here, all services are provided that can be planned in advance through predictive maintenance and which ensure continuous machine operation. Key elements here are the risk analysis of your dosing machines during ongoing production and our associated consulting service for perspective production planning.

### **Online service: Distance no longer matters**

With the Remote Collaboration offer, we use audio, video and machine data communication via a VPN connection for our services in order to support you directly and quickly in an emergency. This enables us to discuss specific tasks with you and eliminate any operating errors. This service can also be used for online training, which reduces the cost and time required for this.

### **On-site service: We will be happy to come to you!**

We can provide you with on-site support in the form of a wide range of services from our service technicians:

- Commissioning of machines
- Creation of complex dosing programs
- Machine inspection according to cost or with service contract
- Machine repairs
- Machine relocation for production site changes
- On-Site Training

### **Service contract and spare parts supply**

By concluding a service contract, you receive optimum support for your production – from regular checks of the optimum functionality of your dosing system, to a system inspection using original spare parts from our high-bay warehouse, to machine repair and rapid assistance in the event of damage.





Inhouse service



On-site service



Online service



Service contract



spare parts supply



## This is why you should use FIP technology in your production process



### Advantages of the Formed-In-Place technology

- Sealing standard in many industrial sectors
- Highly accurate material application controlled by contour robots
- Processing and full curing at room temperature
- Perfect coordination of the material system and dosing system
- Suitable for 2D and complex 3D part geometries
- More efficient use of materials compared to punched seals
- Cheaper compared to 2-C injection molding, as there are no tooling costs
- High degree of future viability, due to suitability for use in a wide variety of industries & applications



## Advantages of our mixing and dosing machines

- Combination of processes (bonding, foaming, caulking, potting)
- High flexibility of the dosing system
- Simple, intuitive operation
- Automatic material preparation incl. handling
- High dosing and repeat accuracy
- Short machine downtimes and cycle times
- Fine-cell foam structure due to dynamic mixing
- Reproducible foam quality
- Ecological high-pressure water rinsing
- Easy maintenance



## Advantages of our FIPFG foam gaskets

- More cost-effective than compact systems due to lower foam density
- Seamless seal / hardly visible coupling point
- Compensation of component tolerances
- Good resilience
- Multiple compression and release processes possible
- Broad range of properties / wide variety of recipes
- Individually adaptable recipes
- Good form fit to the component contour
- Resistant to moisture, dust, temperature & media
- Flame-retardant according to UL 94
- IP classes up to IP 68 or NEMA 4 to 6 and NEMA 12
- Special PU foam with low VOC emissions
- Very fast reacting PU foam (Fast-Cure)



## Perfectly coordinated solutions for material, machine and contract manufacturing from a single source

With the Sonderhoff brand, Henkel has many years of experience in the manufacture of customized 2-component sealing systems, mixing and dosing machines and, as a process expert, the know-how for application-specific material application.

With the Sonderhoff portfolio, we offer you the advantages of a system provider from a single source and the solutions for your technical and commercial challenges.

We ensure efficient production processes in line with the requirements of fully automated series production and are available to you worldwide with our service staff.

If you want to benefit from all the advantages for your production flexibly, quickly, easily and without having to invest in your own procurement, we can take over the sealing of your parts from experts at one of our contract manufacturing locations worldwide. There, the spectrum ranges from prototype sampling and small series to series production on a production scale.

The choice is yours!

You can either opt for our all-inclusive package, consisting of material, machine, and contract manufacturing, supported by application advice, sampling and training. Or you can choose the individual solutions that suit you best. We combine our products and services from a single source to provide you with the optimum solution for your requirements profile.

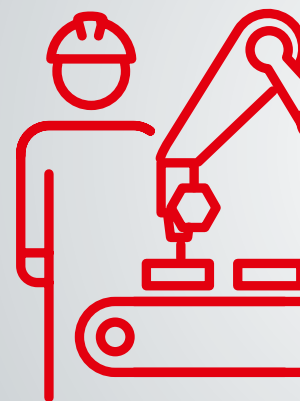

**MANUFACT**

# *Flexibility & Precision*

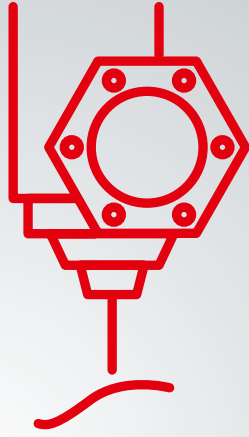

**EQUIPMENT**

# Automation Solutions

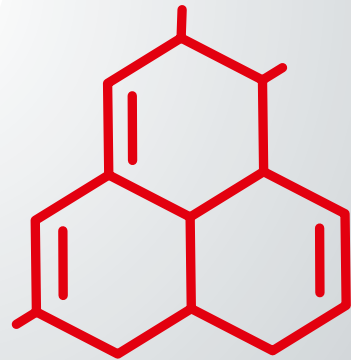

**MATERIALS**



**URING**

# Customer-specific solutions – worldwide and for many industries

The Henkel specialists for the Sonderhoff portfolio  
are available globally

**KOLO, POLAND**  
External Subcontracting Location

**DÜSSELDORF, GERMANY**  
Center of Expertise

**ELGIN, ILLINOIS, USA**  
Regional Hub

**RICHMOND (KANSAS CITY), USA**  
Regional Hub

**DORNBIRN, AUSTRIA**  
Center of Expertise

**BARCELONA, SPAIN**  
External Subcontracting Location

**OGGIONO, ITALY**  
Regional Hub

**INCHEON, KOREA**  
External Subcontracting Location

**SHANGHAI, CHINA**  
Regional Hub

**PUNE, INDIA**  
Regional Hub

**PUNE, INDIA**  
External Subcontracting Location

**SÃO PAULO, BRAZIL**  
External Subcontracting Location

*Global presence*





Every year, more than 300 million seals are manufactured in more than 50 countries using products from Henkel's Sonderhoff portfolio. At our Centers of Expertise and Regional Hubs, our specialists offer application engineering advice, e.g. on the selection of a suitable material system and the sampling of your components, as well as project management for dosing systems and automation. You will receive training from us on how to use the FIPFG technology and we will support you with the selection of spare parts and a regular service offering. Furthermore, we will be pleased to take over parts of your production for you – from small to large series – at our subcontracting locations.

Sales staff at all other Henkel locations worldwide will also be happy to answer any questions and provide you with further information on our sealing, bonding and potting solutions. We look forward to hearing from you.



**Henkel AG & Co. KGaA**

Henkelstraße 67  
40589 Düsseldorf  
Germany  
Tel.: +49 211 797-0  
Fax: +49 211 798 4008

[www.henkel.com](http://www.henkel.com)  
[www.sonderhoff.com](http://www.sonderhoff.com)

Get in contact with us



The description of the possible fields of use of our products as well as the technical data and values only have a general character and do not mean that a certain product can be used under all conditions in the respective field of use. In this respect, the stated field of use is not a binding specification or usage provision. Due to the great number of environment variables and their influences (e.g. temperature, test specimens, size, interaction with substrates, influence of machines, or the like) you as our customer must check whether the product is suitable for your specific field of use. We will be pleased to assist and advise you in this respect. Except as otherwise noted, all marks used above are trademarks and/or registered trademarks of Henkel and its affiliates in the U.S., Germany and elsewhere.

© 2022 Henkel AG & Co. KGaA. All rights reserved.